

# Earthshine Design

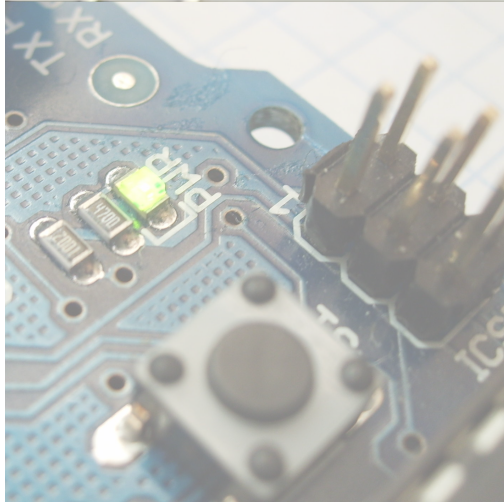

## Arduino Starter Kit Manual

A Complete Beginners Guide to the Arduino

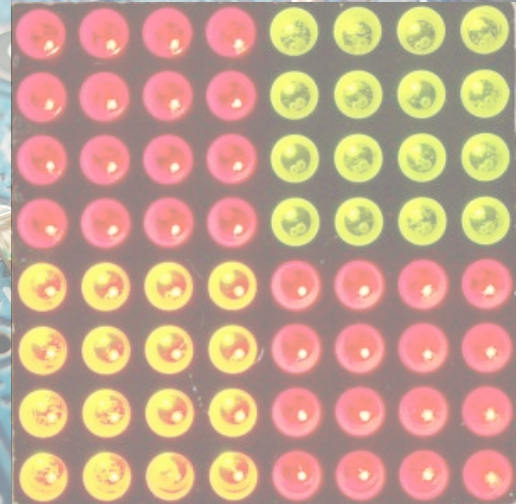
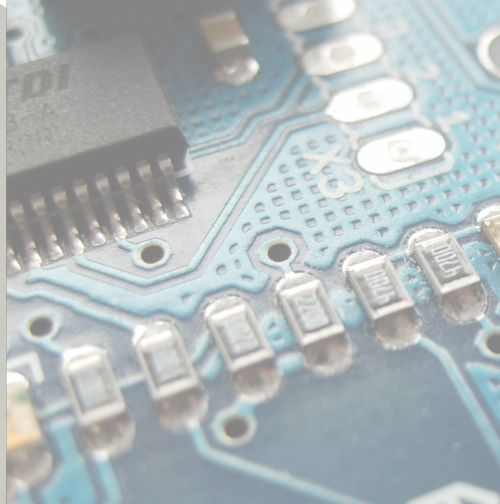
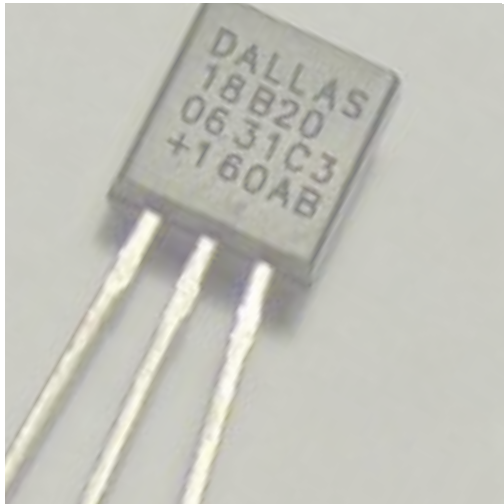
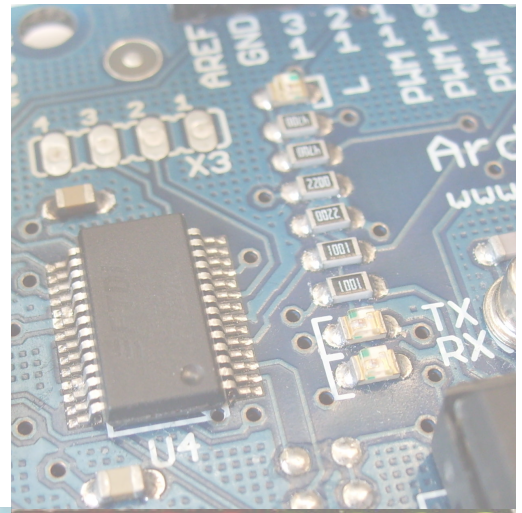
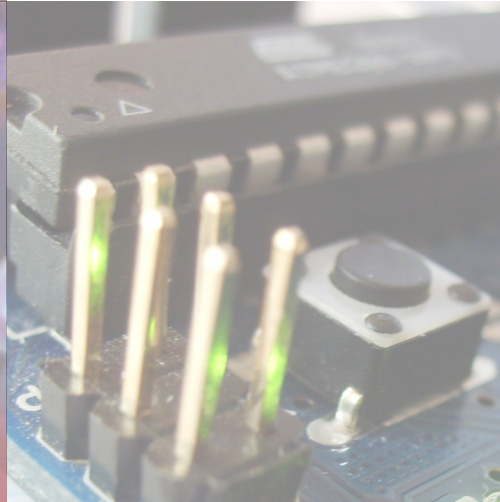
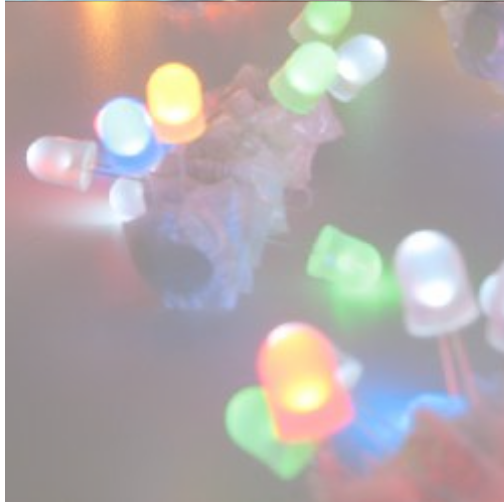

# Earthshine Design

## Arduino Starters Kit Manual

A Complete Beginners guide to the Arduino

By Mike McRoberts

©2009 M.R.McRoberts  
Published 2009 by Earthshine Design.  
Design: Mike McRoberts

First Edition - May 2009  
Revision 1 - July 2009  
Revision 2 - September 2009

## License

THE WORK (AS DEFINED BELOW) IS PROVIDED UNDER THE TERMS OF THIS CREATIVE COMMONS PUBLIC LICENSE ("CCPL" OR "LICENSE"). THE WORK IS PROTECTED BY COPYRIGHT AND/OR OTHER APPLICABLE LAW. ANY USE OF THE WORK OTHER THAN AS AUTHORIZED UNDER THIS LICENSE OR COPYRIGHT LAW IS PROHIBITED.

BY EXERCISING ANY RIGHTS TO THE WORK PROVIDED HERE, YOU ACCEPT AND AGREE TO BE BOUND BY THE TERMS OF THIS LICENSE. TO THE EXTENT THIS LICENSE MAY BE CONSIDERED TO BE A CONTRACT, THE LICENSOR GRANTS YOU THE RIGHTS CONTAINED HERE IN CONSIDERATION OF YOUR ACCEPTANCE OF SUCH TERMS AND CONDITIONS.

### 1. Definitions

- a. **"Adaptation"** means a work based upon the Work, or upon the Work and other pre-existing works, such as a translation, adaptation, derivative work, arrangement of music or other alterations of a literary or artistic work, or phonogram or performance and includes cinematographic adaptations or any other form in which the Work may be recast, transformed, or adapted including in any form recognizably derived from the original, except that a work that constitutes a Collection will not be considered an Adaptation for the purpose of this License. For the avoidance of doubt, where the Work is a musical work, performance or phonogram, the synchronization of the Work in timed-relation with a moving image ("synching") will be considered an Adaptation for the purpose of this License.
- b. **"Collection"** means a collection of literary or artistic works, such as encyclopedias and anthologies, or performances, phonograms or broadcasts, or other works or subject matter other than works listed in Section 1(f) below, which, by reason of the selection and arrangement of their contents, constitute intellectual creations, in which the Work is included in its entirety in unmodified form along with one or more other contributions, each constituting separate and independent works in themselves, which together are assembled into a collective whole. A work that constitutes a Collection will not be considered an Adaptation (as defined above) for the purposes of this License.
- c. **"Distribute"** means to make available to the public the original and copies of the Work through sale or other transfer of ownership.
- d. **"Licensor"** means the individual, individuals, entity or entities that offer(s) the Work under the terms of this License.
- e. **"Original Author"** means, in the case of a literary or artistic work, the individual, individuals, entity or entities who created the Work or if no individual or entity can be identified, the publisher; and in addition (i) in the case of a performance the actors, singers, musicians, dancers, and other persons who act, sing, deliver, declaim, play in, interpret or otherwise perform literary or artistic works or expressions of folklore; (ii) in the case of a phonogram the producer being the person or legal entity who first fixes the sounds of a performance or other sounds; and, (iii) in the case of broadcasts, the organization that transmits the broadcast.
- f. **"Work"** means the literary and/or artistic work offered under the terms of this License including without limitation any production in the literary, scientific and artistic domain, whatever may be the mode or form of its expression including digital form, such as a book, pamphlet and other writing; a lecture, address, sermon or other work of the same nature; a dramatic or dramatico-musical work; a choreographic work or entertainment in dumb show; a musical composition with or without words; a cinematographic work to which are assimilated works expressed by a process analogous to cinematography; a work of drawing, painting, architecture, sculpture, engraving or lithography; a photographic work to which are assimilated works expressed by a process analogous to photography; a work of applied art; an illustration, map, plan, sketch or three-dimensional work relative to geography, topography, architecture or science; a performance; a broadcast; a phonogram; a compilation of data to the extent it is protected as a copyrightable work; or a work performed by a variety or circus performer to the extent it is not otherwise considered a literary or artistic work.
- g. **"You"** means an individual or entity exercising rights under this License who has not previously violated the terms of this License with respect to the Work, or who has received express permission from the Licensor to exercise rights under this License despite a previous violation.
- h. **"Publicly Perform"** means to perform public recitations of the Work and to communicate to the public those public recitations, by any means or process, including by wire or wireless means or public digital performances; to make available to the public Works in such a way that members of the public may access these Works from a place and at a place individually chosen by them; to perform the Work to the public by any means or process and the communication to the public of the performances of the Work, including by public digital performance; to broadcast and rebroadcast the Work by any means including signs, sounds or images.
- i. **"Reproduce"** means to make copies of the Work by any means including without limitation by sound or visual recordings and the right of fixation and reproducing fixations of the Work, including storage of a protected performance or phonogram in digital form or other electronic medium.

**2. Fair Dealing Rights.** Nothing in this License is intended to reduce, limit, or restrict any uses free from copyright or rights arising from limitations or exceptions that are provided for in connection with the copyright protection under copyright law or other applicable laws.

**3. License Grant.** Subject to the terms and conditions of this License, Licensor hereby grants You a worldwide, royalty-free, non-exclusive, perpetual (for the duration of the applicable copyright) license to exercise the rights in the Work as stated below:

- a. to Reproduce the Work, to incorporate the Work into one or more Collections, and to Reproduce the Work as incorporated in the Collections; and,
- b. to Distribute and Publicly Perform the Work including as incorporated in Collections.

The above rights may be exercised in all media and formats whether now known or hereafter devised. The above rights include the right to make such modifications as are technically necessary to exercise the rights in other media and formats, but otherwise you have no rights to make Adaptations. Subject to 8(f), all rights not expressly granted by Licensor are hereby reserved, including but not limited to the rights set forth in Section 4(d).

**4. Restrictions.** The license granted in Section 3 above is expressly made subject to and limited by the following restrictions:

- a. You may Distribute or Publicly Perform the Work only under the terms of this License. You must include a copy of, or the Uniform Resource Identifier (URI) for, this License with every copy of the Work You Distribute or Publicly Perform. You may not offer or impose any terms on the Work that restrict the terms of this License or the ability of the recipient of the Work to exercise the rights granted to that recipient under the terms of the License. You may not sublicense the Work. You must keep intact all notices that refer to this License and to the disclaimer of warranties with every copy of the Work You Distribute or Publicly Perform. When You Distribute or Publicly Perform the Work, You may not impose any effective technological measures on the Work that restrict the ability of a recipient of the Work from You to exercise the rights granted to that recipient under the terms of the License. This Section 4(a) applies to the Work as incorporated in a Collection, but this does not require the Collection apart from the Work itself to be made subject to the terms of this License. If You create a Collection, upon notice from any Licensor You must, to the extent practicable, remove from the Collection any credit as required by Section 4(c), as requested.
- b. You may not exercise any of the rights granted to You in Section 3 above in any manner that is primarily intended for or directed toward commercial advantage or private monetary compensation. The exchange of the Work for other copyrighted works by means of digital file-sharing or otherwise shall not be considered to be intended for or directed toward commercial advantage or private monetary compensation, provided there is no payment of any monetary compensation in connection with the exchange of copyrighted works.
- c. If You Distribute, or Publicly Perform the Work or Collections, You must, unless a request has been made pursuant to Section 4 (a), keep intact all copyright notices for the Work and provide, reasonable to the medium or means You are utilizing: (i) the name of the Original Author (or pseudonym, if applicable) if supplied, and/or if the Original Author and/or Licensor designate another party or parties (e.g., a sponsor institute, publishing entity, journal) for attribution ("Attribution Parties") in Licensor's copyright notice, terms of service or by other reasonable means, the name of such party or parties; (ii) the title of the Work if supplied; (iii) to the extent reasonably practicable, the URI, if any, that Licensor specifies to be associated with the Work, unless such URI does not refer to the copyright notice or licensing information for the Work. The credit required by this Section 4(c) may be implemented in any reasonable manner; provided, however, that in the case of a Collection, at a minimum such credit will appear, if a credit for all contributing authors of Collection appears, then as part of these credits and in a manner at least as prominent as the credits for the other contributing authors. For the avoidance of doubt, You may only use the credit required by this Section for the purpose of attribution in the manner set out above and, by exercising Your rights under this License, You may not implicitly or explicitly assert or imply any connection with, sponsorship or endorsement by the Original Author, Licensor and/or Attribution Parties, as appropriate, of You or Your use of the Work, without the separate, express prior written permission of the Original Author, Licensor and/or Attribution Parties.
- d. For the avoidance of doubt:
  - i. **Non-waivable Compulsory License Schemes.** In those jurisdictions in which the right to collect royalties through any statutory or compulsory licensing scheme cannot be waived, the Licensor reserves the exclusive right to collect such royalties for any exercise by You of the rights granted under this License;
  - ii. **Waivable Compulsory License Schemes.** In those jurisdictions in which the right to collect royalties through any statutory or compulsory licensing scheme can be waived, the Licensor reserves the exclusive right to collect such royalties for any exercise by You of the rights granted under this License if Your exercise of such rights is for a purpose or use which is otherwise than noncommercial as permitted under Section 4(b) and otherwise waives the right to collect royalties through any statutory or compulsory licensing scheme; and,
  - iii. **Voluntary License Schemes.** The Licensor reserves the right to collect royalties, whether individually or, in the event that the Licensor is a member of a collecting society that administers voluntary licensing schemes, via that society, from any exercise by You of the rights granted under this License that is for a purpose or use which is otherwise than noncommercial as permitted under Section 4(b).
- e. Except as otherwise agreed in writing by the Licensor or as may be otherwise permitted by applicable law, if You Reproduce, Distribute or Publicly Perform the Work either by itself or as part of any Collections, You must not distort, mutilate, modify or take other derogatory action in relation to the Work which would be prejudicial to the Original Author's honor or reputation.

#### **5. Representations, Warranties and Disclaimer**

UNLESS OTHERWISE MUTUALLY AGREED BY THE PARTIES IN WRITING, LICENSOR OFFERS THE WORK AS-IS AND MAKES NO REPRESENTATIONS OR WARRANTIES OF ANY KIND CONCERNING THE WORK, EXPRESS, IMPLIED, STATUTORY OR OTHERWISE, INCLUDING, WITHOUT LIMITATION, WARRANTIES OF TITLE, MERCHANTABILITY, FITNESS FOR A PARTICULAR PURPOSE, NON-INFRINGEMENT, OR THE ABSENCE OF LATENT OR OTHER DEFECTS, ACCURACY, OR THE PRESENCE OF ABSENCE OF ERRORS, WHETHER OR NOT DISCOVERABLE. SOME JURISDICTIONS DO NOT ALLOW THE EXCLUSION OF IMPLIED WARRANTIES, SO SUCH EXCLUSION MAY NOT APPLY TO YOU.

**6. Limitation on Liability.** EXCEPT TO THE EXTENT REQUIRED BY APPLICABLE LAW, IN NO EVENT WILL LICENSOR BE LIABLE TO YOU ON ANY LEGAL THEORY FOR ANY SPECIAL, INCIDENTAL, CONSEQUENTIAL, PUNITIVE OR EXEMPLARY DAMAGES

ARISING OUT OF THIS LICENSE OR THE USE OF THE WORK, EVEN IF LICENSOR HAS BEEN ADVISED OF THE POSSIBILITY OF SUCH DAMAGES.

## 7. Termination

- a. This License and the rights granted hereunder will terminate automatically upon any breach by You of the terms of this License. Individuals or entities who have received Collections from You under this License, however, will not have their licenses terminated provided such individuals or entities remain in full compliance with those licenses. Sections 1, 2, 5, 6, 7, and 8 will survive any termination of this License.
- b. Subject to the above terms and conditions, the license granted here is perpetual (for the duration of the applicable copyright in the Work). Notwithstanding the above, Licensor reserves the right to release the Work under different license terms or to stop distributing the Work at any time; provided, however that any such election will not serve to withdraw this License (or any other license that has been, or is required to be, granted under the terms of this License), and this License will continue in full force and effect unless terminated as stated above.

## 8. Miscellaneous

- a. Each time You Distribute or Publicly Perform the Work or a Collection, the Licensor offers to the recipient a license to the Work on the same terms and conditions as the license granted to You under this License.
- b. If any provision of this License is invalid or unenforceable under applicable law, it shall not affect the validity or enforceability of the remainder of the terms of this License, and without further action by the parties to this agreement, such provision shall be reformed to the minimum extent necessary to make such provision valid and enforceable.
- c. No term or provision of this License shall be deemed waived and no breach consented to unless such waiver or consent shall be in writing and signed by the party to be charged with such waiver or consent.
- d. This License constitutes the entire agreement between the parties with respect to the Work licensed here. There are no understandings, agreements or representations with respect to the Work not specified here. Licensor shall not be bound by any additional provisions that may appear in any communication from You. This License may not be modified without the mutual written agreement of the Licensor and You.
- e. The rights granted under, and the subject matter referenced, in this License were drafted utilizing the terminology of the Berne Convention for the Protection of Literary and Artistic Works (as amended on September 28, 1979), the Rome Convention of 1961, the WIPO Copyright Treaty of 1996, the WIPO Performances and Phonograms Treaty of 1996 and the Universal Copyright Convention (as revised on July 24, 1971). These rights and subject matter take effect in the relevant jurisdiction in which the License terms are sought to be enforced according to the corresponding provisions of the implementation of those treaty provisions in the applicable national law. If the standard suite of rights granted under applicable copyright law includes additional rights not granted under this License, such additional rights are deemed to be included in the License; this License is not intended to restrict the license of any rights under applicable law.

## PLAIN LANGUAGE SUMMARY:

**You are free:**

to **Share** - to copy, distribute and transmit the work

**Under the following conditions:**

**Attribution** - You must attribute this work to Mike McRoberts (with link)

**Noncommercial** - You may not use this work for commercial purposes.

**No Derivative Works** - You may not alter, transform, or build upon this work.

<http://creativecommons.org/licenses/by-nc-nd/3.0/>

# Contents

Introduction	7	Project 12 - Piezo Sounder Melody Player	71
The Starter Kit Contents	8	Code Overview	72
What exactly is an Arduino?	9	Hardware Overview	74
Getting Started	11	Project 13 - Serial Temperature Sensor	76
Upload your first sketch	13	Code Overview	77
The Arduino IDE	15	Hardware Overview	79
The Projects	19	Project 14 - Light Sensor	81
Project 1 - LED Flasher	21	Code Overview	82
Code Overview	22	Hardware Overview	83
Hardware Overview	25	Project 15 - Shift Register 8-Bit Binary Counter	84
Project 2 - SOS Morse Code Signaller	29	The Binary Number System	87
Code Overview	30	Hardware Overview	88
Project 3 - Traffic Lights	32	Code Overview	90
Project 4 - Interactive Traffic Lights	34	Bitwise Operators	91
Code Overview	37	Code Overview (continued)	92
Project 5 - LED Chase Effect	41	Project 16 - Dial 8-Bit Binary Counters	93
Code Overview	42	Code & Hardware Overview	96
Project 6 - Interactive LED Chase Effect	44	Project 17 - LED Dot Matrix - Basic Animation	97
Code Overview	45	Code Overview	103
Hardware Overview	46		
Project 7 - Pulsating Lamp	48		
Code Overview	49		
Project 8 - Mood Lamp	51		
Code Overview	52		
Project 9 - LED Fire Effect	55		
Code Overview	56		
Project 10 - Serial Controlled Mood Lamp	58		
Code Overview	60		
Project 11 - Drive a DC Motor	67		
Code Overview	68		
Hardware Overview	69		

# Introduction

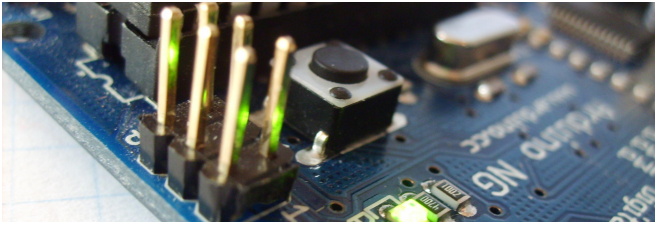

Thank you for purchasing the Earthshine Design Arduino Starter Kit. You are now well on your way in your journey into the wonderful world of the Arduino and microcontroller electronics.

This book will guide you, step by step, through using the Starter Kit to learn about the Arduino hardware, software and general electronics theory. Through the use of electronic projects we will take you from the level of complete beginner through to having an intermediate set of skills in using the Arduino.

The purpose of this book and the kit is to give you a gentle introduction to the Arduino, electronics and programming in C and to set you up with the necessary skills needed to progress beyond the book and the kit into the world of the Arduino and microcontroller electronics.

The booklet has been written presuming that you have no prior knowledge of electronics, the Arduino hardware, software environment or of computer programming. At no time will we get too deep into electronics or programming in C. There are many other resources available for free that will enable you to learn a lot more about this subject if you wish to go further. The best possible way to learn the Arduino, after using this kit of course, is to join the Arduino Forum on the Arduino website and to check out the code and hardware examples in the 'Playground' section of the Arduino website too.

We hope you enjoy using the kit and get satisfaction from creating the projects and seeing your creations come to life.

## How to use it

The book starts off with an introduction to the Arduino, how to set up the hardware, install the software, etc. We then explain the Arduino IDE and how to use it before we dive right into some projects progressing from very basic stuff through to advanced topics. Each project will start off with a description of how to set up the hardware and what code is needed to get it working. We will then describe separately the code and the hardware and explain in some detail how it works.

Everything will be explained in clear and easy to follow steps. The book contains a lot of diagrams and photographs to make it as easy as possible to check that you are following along with the project correctly.

## What you will need

Firstly, you will need access to the internet to be able to download the Arduino IDE (Integrated Development Environment) and to also download the Code Samples within this book (if you don't want to type them out yourself) and also any code libraries that may be necessary to get your project working.

You will need a well lit table or other flat surface to lay out your components and this will need to be next to your desktop or laptop PC to enable you to upload the code to the Arduino. Remember that you are working with electricity (although low voltage DC) and therefore a metal table or surface will first need to be covered in a non-conductive material (e.g. tablecloth, paper, etc.) before laying out your materials.

Also of some benefit, although not essential, may be a pair of wire cutters, a pair of long nosed pliers and a wire stripper.















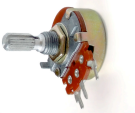
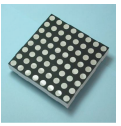

A notepad and pen will also come in handy for drawing out rough schematics, working out concepts and designs, etc.

Finally, the most important thing you will need is enthusiasm and a willingness to learn. The Arduino is designed as a simple and cheap way to get involved in microcontroller electronics and nothing is too hard to learn if you are willing to at least 'give it a go'. The Earthshine Design Arduino Starter Kit will help you on that journey and introduce you to this exciting and creative hobby.

*Mike McRoberts*  
[Mike@earthshinedesign.co.uk](mailto:Mike@earthshinedesign.co.uk)  
May 2009

# The Starter Kit Contents

Please note that your kit contents may look slightly different to those listed here

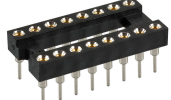
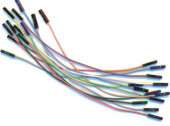
 Freeduino or Roboduino Board	 9v DC Power Supply	 Breadboard	 USB Cable	 Piezo Sounder
 10 x Clear RED 5mm LED's	 10 x Clear Blue 5mm LED's	 10 x Clear Green 5mm LED's	 5 x 1N4001 Diodes	 3-Way Terminal Block
 10 x Yellow Diffused 5mm LED's	 10 x Green Diffused 5mm LED's	 10 x RED Diffused 5mm LED's	 5 x Tactile Switches	 4K7 Potentiometer
 Light Dependent Resistor	 8x8 Mini LED Dot Matrix Display	 2 x BC547 NPN Transistors	 TIP-120 NPN Transistor	 DC Motor
 10 x 100R Resistors	 10 x 150R Resistors	 10 x 240R Resistors	 10 x 470R Resistors	 10 x 1KR Resistors
 10 x 1K5R Resistors	 10 x 1MR Resistors	 LM35DT Temperature Sensor	 3 x 74HC595 Shift Register IC's	 3 x 16-Pin IC Socket
 Jumper Wire Kit	 Component Case	 eBook		



# What exactly is an Arduino?

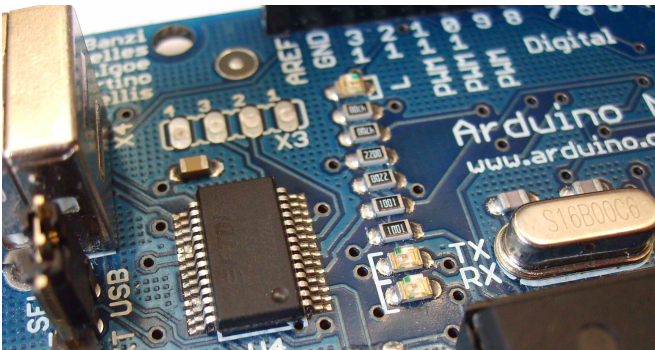

Now that you are a proud owner of an Arduino, or an Arduino clone, it might help if you knew what it was and what you can do with it.

In its simplest form, an Arduino is a tiny computer that you can program to process inputs and outputs going to and from the chip.

The Arduino is what is known as a Physical or Embedded Computing platform, which means that it is an interactive system, that through the use of hardware and software can interact with its environment.

For example, a simple use of the Arduino would be to turn a light on for a set period of time, let's say 30 seconds, after a button has been pressed (we will build this very same project later in the book). In this example, the Arduino would have a lamp connected to it as well as a button. The Arduino would sit patiently waiting for the button to be pressed. When you press the button it would then turn the lamp on and start counting. Once it had counted 30 seconds it would then turn the lamp off and then carry on sitting there waiting for another button press. You could use this set-up to control a lamp in an under-stairs cupboard for example. You could extend this example to sense when the cupboard door was opened and automatically turn the light on, turning it off after a set period of time.

The Arduino can be used to develop stand-alone interactive objects or it can be connected to a computer to retrieve or send data to the Arduino and then act on that data (e.g. Send sensor data out to the internet).

The Arduino can be connected to LED's. Dot Matrix displays, LED displays, buttons, switches, motors, temperature sensors, pressure sensors, distance sensors, webcams, printers, GPS receivers, ethernet modules,

The Arduino board is made of an an Atmel AVR Microprocessor, a crystal or oscillator (basically a crude clock that sends time pulses to the microcontroller to enable it to operate at the correct

speed) and a 5-volt linear regulator. Depending on what type of Arduino you have, you may also have a USB connector to enable it to be connected to a PC or Mac to upload or retrieve data. The board exposes the microcontroller's I/O (Input/Output) pins to enable you to connect those pins to other circuits or to sensors, etc.

To program the Arduino (make it do what you want it to) you also use the Arduino IDE (Integrated Development Environment), which is a piece of free software, that enables you to program in the language that the Arduino understands. In the case of the Arduino the language is C. The IDE enables you to write a computer program, which is a set of step-by-step instructions that you then upload to the Arduino. Then your Arduino will carry out those instructions and interact with the world outside. In the Arduino world, programs are known as 'Sketches'.

```
/* Blink
 * The basic Arduino example. Turns on an LED on for one second,
 * then off for one second, and so on... We use pin 13 because,
 * depending on your Arduino board, it has either a built-in LED
 * or a built-in resistor so that you need only an LED.
 * http://www.arduino.cc/en/Tutorial/Blink
 */
int ledPin = 13; // LED connected to digital pin 13
void setup() // run once, when the sketch starts
{
  pinMode(ledPin, OUTPUT); // sets the digital pin as output
}
void loop() // run over and over again
{
  digitalWrite(ledPin, HIGH); // sets the LED on
  delay(1000); // waits for a second
  digitalWrite(ledPin, LOW); // sets the LED off
  delay(1000); // waits for a second
}
```

The Arduino hardware and software are both Open Source, which means the code, the schematics, design, etc. are all open for anyone to take freely and do what they like with it.

This means there is nothing stopping anyone from taking the schematics and PCB designs of the Arduino and making their own and selling them. This is perfectly legal, and indeed the whole purpose of Open Source, and indeed the Freduino that comes with the Earthshine Design Arduino Starter Kit is a perfect example of where someone has taken the Arduino PCB design, made their own and are selling it under the Freduino name. You could even make your own

Arduino, with just a few cheap components, on a breadboard.

The only stipulation that the Arduino development team put on outside developers is that the Arduino name can only be used exclusively by them on their own products and hence the clone boards have names such as Freeduino, Boarduino, Roboduino, etc.

As the designs are open source, any clone board, such as the Freeduino, is 100% compatible with the Arduino and therefore any software, hardware, shields, etc. will all be 100% compatible with a genuine Arduino.

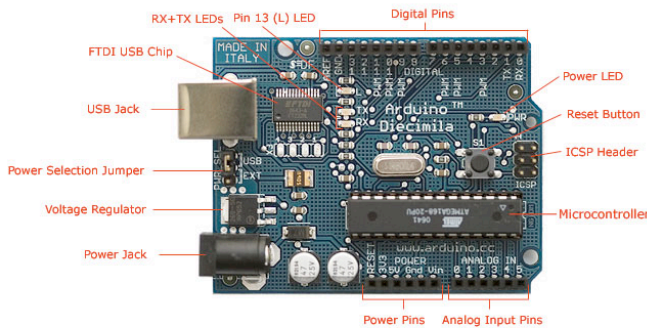

Photograph by SparkFun Electronics. Used under the Creative Commons Attribution Share-Alike 3.0 license.

The Arduino can also be extended with the use of 'Shields' which are circuit boards containing other devices (e.g. GPS receivers, LCD Displays, Ethernet connections, etc.) that you can simply slot into the top of your Arduino to get extra functionality. You don't have to use a shield if you don't want to as you can make the exact same circuitry using a breadboard, some veroboard or even by making your own PCB's.

There are many different variants of the Arduino available. The most common one is the Diecimila or the Duemilanove. You can also get Mini, Nano and Bluetooth Arduino's.

New to the product line is the new Arduino Mega with increased memory and number of I/O pins.

Probably the most versatile Arduino, and hence the reason it is the most popular, is the Duemilanove. This is because it uses a standard 28 pin chip, attached to an IC Socket. The beauty of this systems is that if you make something neat with the Arduino and then want to turn it into something permanent (e.g. Or under-stairs cupboard light), then instead of using the relatively expensive Arduino board, you can simply use the Arduino to develop your device, then pop the chip out of the board and place it into your own circuit board in your custom device. You would then have made a custom embedded device, which is really cool.

Then, for a couple of quid or bucks you can replace the AVR chip in your Arduino with a new one. The chip must be pre-programmed with the Arduino Bootloader to enable it to work with the Arduino IDE, but you can either burn the Bootloader yourself if you purchase an AVR Programmer, or you can buy these pre-programmed from many suppliers around the world. Of course, Earthshine Design provide pre-programmed Arduino chips in it' store for a very reasonable price.

If you do a search on the Internet by simply typing 'Arduino' into the search box of your favourite search engine, you will be amazed at the huge amount of websites dedicated to the Arduino. You can find a mind boggling amount of information on projects made with the Arduino and if you have a project in mind, will easily find information that will help you to get your project up and running easily.

The Arduino is an amazing device and will enable you to make anything from interactive works of art to robots. With a little enthusiasm to learn how to program the Arduino and make it interact with other components a well as a bit of imagination, you can build anything you want.

This book and the kit will give you the necessary skills needed to get started in this exciting and creative hobby.

So, now you know what an Arduino is and what you can do with it, let's open up the starter kit and dive right in.

# Getting Started

This section will presume you have a PC running Windows or a Mac running OSX (10.3.9 or later). If you use Linux as your Operating System, then refer to the Getting Started instructions on the Arduino website at <http://www.arduino.cc/playground/Learning/Linux>

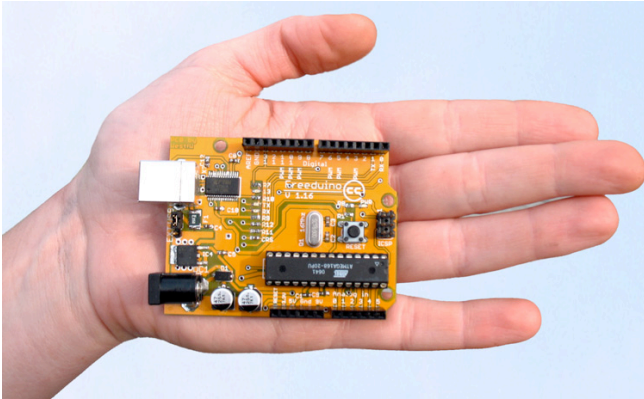

## Get the Freeduino and the USB Cable

Firstly, get your Freeduino board and lay it on the table in front of you. Take the USB cable and plug the B plug (the fatter squarer end) into the USB socket on the Freeduino.

At this stage do NOT connect the Freeduino to your PC or Mac yet.



## Download the Arduino IDE

Download the Arduino IDE from the Arduino [download page](#). As of the time of writing this book, the latest IDE version is 0015. The file is a ZIP file so you will need to uncompress it. Once the download has finished, unzip the file, making sure that you preserve the folder structure as it is and do not make any changes.

If you double-click the folder, you will see a few files and sub-folders inside.

## Install the USB Drivers

If you are using Windows you will find the drivers in the `drivers/FTDI USB Drivers` directory of the Arduino distribution. In the next stage ("Connect the Freeduino"), you will point Windows's Add New Hardware wizard to these drivers.

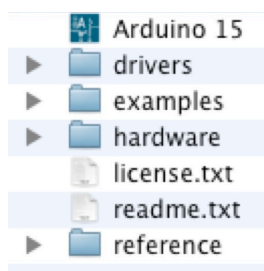

If you have a Mac these are in the `drivers` directory. If you have an older Mac like a PowerBook, iBook, G4 or G5, you should use the PPC drivers: `FTDIUSBSerialDriver_v2_1_9.dmg`. If you have a newer Mac with an Intel chip, you need the Intel drivers: `FTDIUSBSerialDriver_v2_2_9_Intel.dmg`. Double-click to mount the disk image and run the included `FTDIUSBSerialDriver.pkg`.

The latest version of the drivers can be found on the [FTDI website](#).

## Connect the Freeduino

First, make sure that the little power jumper, between the power and USB sockets, is set to USB and not EXTERNAL power (not applicable if you have a Roboduino board, which has an Auto Power Select function).

Using this jumper you can either power the board from the USB port (good for low current devices like LED's, etc.) or from an external power supply (6-12V DC).

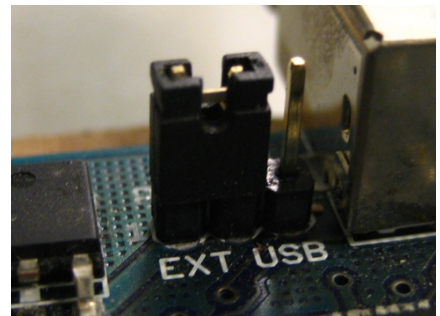

Now, connect the other end of the USB cable into the USB socket on your PC or Mac. You will now see the small power LED (marked PWR above the RESET switch) light up to show you have power to the board.

If you have a Mac, this stage of the process is complete and you can move on to the next Chapter. If you are using Windows, there are a few more steps to complete (Damn you Bill Gates!).

On Windows the **Found New Hardware Wizard** will now open up as Windows will have detected that you have connected a new piece of hardware (your Freeduino board) to your PC. Tell it NOT to connect to Windows update (Select **No, not at this time**) and then click **Next**.



On the next page select **“Install from a list or specific location (Advanced)”** and click **Next**.

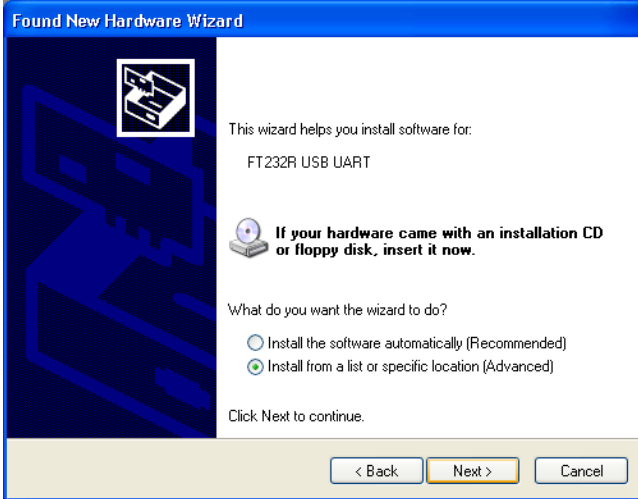

Make sure that **“Search for the best driver in these locations”** is checked.

Uncheck **“Search removable media”**. Check **“Include this location in the search”** and then click the **Browse** button. Browse to the location of the USB drivers and then click **Next**.

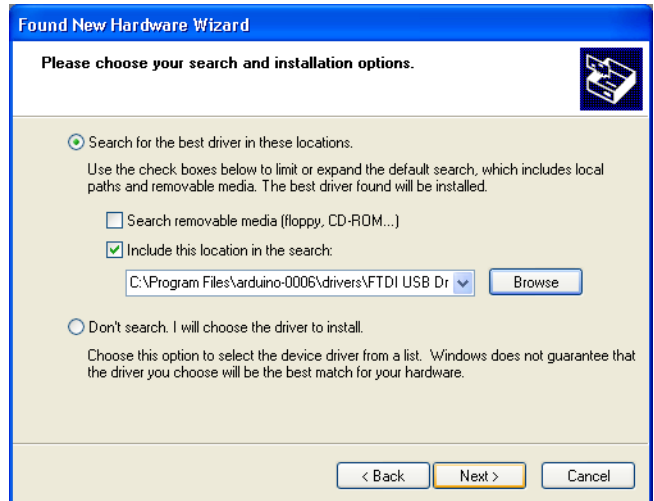

The wizard will now search for a suitable driver and then tell you that a **“USB Serial Converter”** has been found and that the hardware wizard is now complete. Click **Finish**.

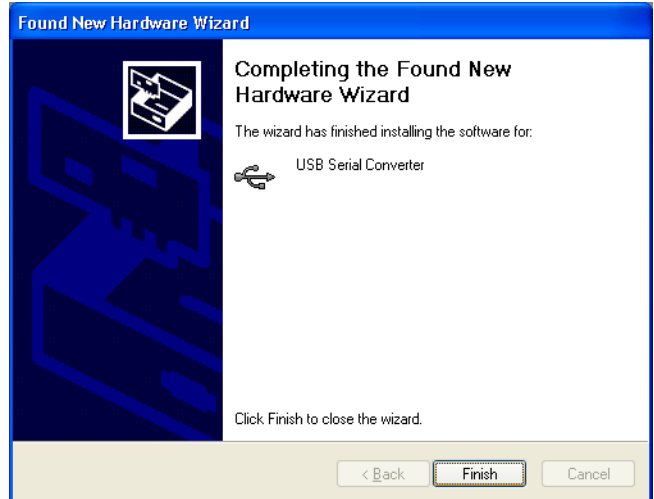

You are now ready to upload your first Sketch.

# Upload your First Sketch

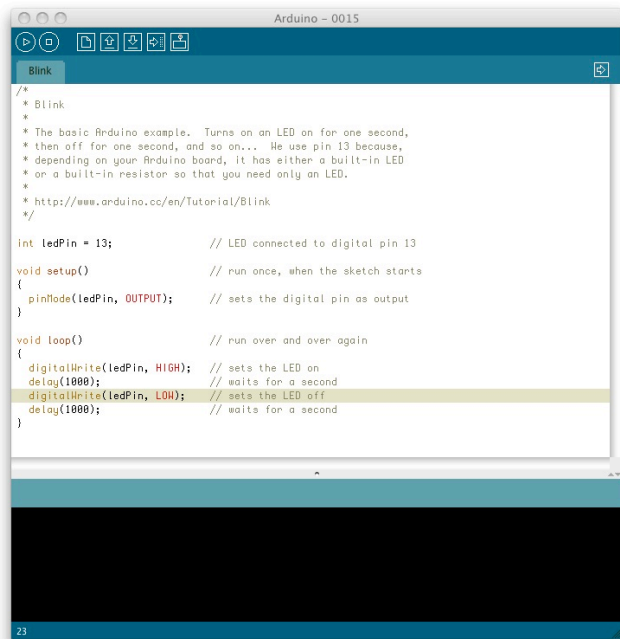

you will see the Sketch inside the white code window.

Now, before we upload the Sketch, we need to tell the IDE what kind of Arduino we are using and the details of our USB port. Go to the file menu and click Tools, then click on Board. You will be presented with a list of all of the different kinds of Arduino board that can be connected to the IDE. Our Freeduino board will either be fitted with an Atmega328 or an Atmega168 chip so choose “Arduino Duemilanove w/ATmega328” if you have a 328 chip or “Arduino Diecimila or Duemilanove w/ ATmega168” if you have a 168 chip.

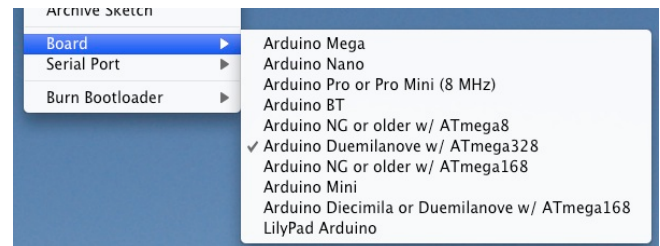

Now that your Freeduino has been connected and the drivers for the USB chip have been installed, we are now ready to try out the Arduino for the first time and upload your first Sketch.

Navigate to your newly unzipped Arduino folder and look for the Arduino IDE icon, which looks something like this....



Double click the ICON to open up the IDE. You will then be presented with a blue and white screen with a default sketch loaded inside.

This is the Arduino IDE (Integrated Development Environment) and is where you will write your Sketches (programs) to upload to your Arduino board.

We will take a look at the IDE in a little more detail in the next chapter. For now, simply click File in the file menu and scroll down to Sketchbook. Then scroll down to Examples and click it. You will be presented with a list of Example sketches that you can use to try out your Arduino. Now click on Digital and inside there you will find an example Sketch called Blink. Click on this.

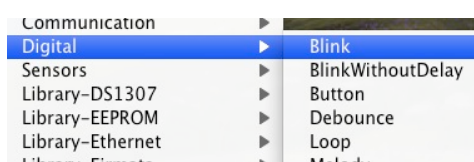
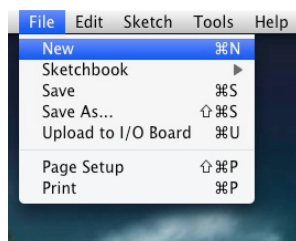

The Blink Sketch will now be loaded into the IDE and

Now you need to tell the IDE the details of your USB port, so now click on Tools again, scroll down to Serial Port and a list of the available serial ports on your system will be displayed. You need to choose the one that refers to your USB cable, which is usually listed as something like /dev/tty.usbserial-xxxx on a Mac or something like Com 4 on Windows so click on that. If not sure, try each one till you find one that works.

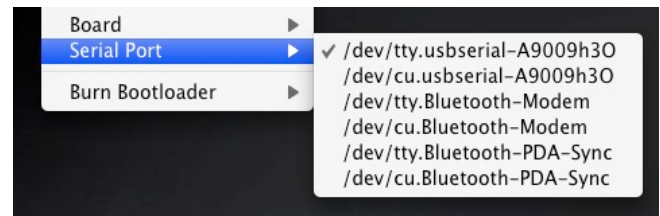

Now that you have selected the correct board and USB port you are ready to upload the Blink Sketch to the board.

You can either click the Upload button, which is the 6<sup>th</sup> button from the left at the top with an arrow pointing to the right (hover your mouse pointer over the buttons to see what they are) or by clicking on File in the file menu and scrolling down to Upload to I/O Board and clicking on that.

Presuming everything has been set up correctly you will now see the RX and TX LED's (and also LED 13) on the Freeduino flash on and off very quickly as data is uploaded to the board. You will see *Uploading to I/O Board....* Just below the code window too.

Once the data has been uploaded to the board successfully you will get a Done Uploading message in the IDE and the RX/TX LED's will stop flashing.

The Arduino will now reset itself and immediately start to run the Sketch that you have just uploaded.

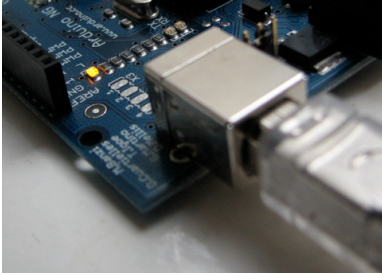

The Blink sketch is a very simple sketch that blinks LED 13, which is a tiny green LED soldered to the board and also connected to Digital Pin 13 from the Microcontroller, and will make it flash on

and off every 1000 milliseconds, or 1 second.

If your sketch has uploaded successfully, you will now see this LED happily flashing on and off slowly on your board.

If so, congratulations, you have just successfully installed your Arduino, uploaded and ran your first sketch.

We will now explain a bit more about the Arduino IDE and how to use it before moving onto the projects that you can carry out using the hardware supplied with the kit. For our first project we will carry out this Blink LED sketch again, but this time using an LED that we will physically connect to one of the digital output pins on the Arduino. We will also explain the hardware and software involved in this simple project. But first, let's take a closer look at the Arduino IDE.

# The Arduino IDE

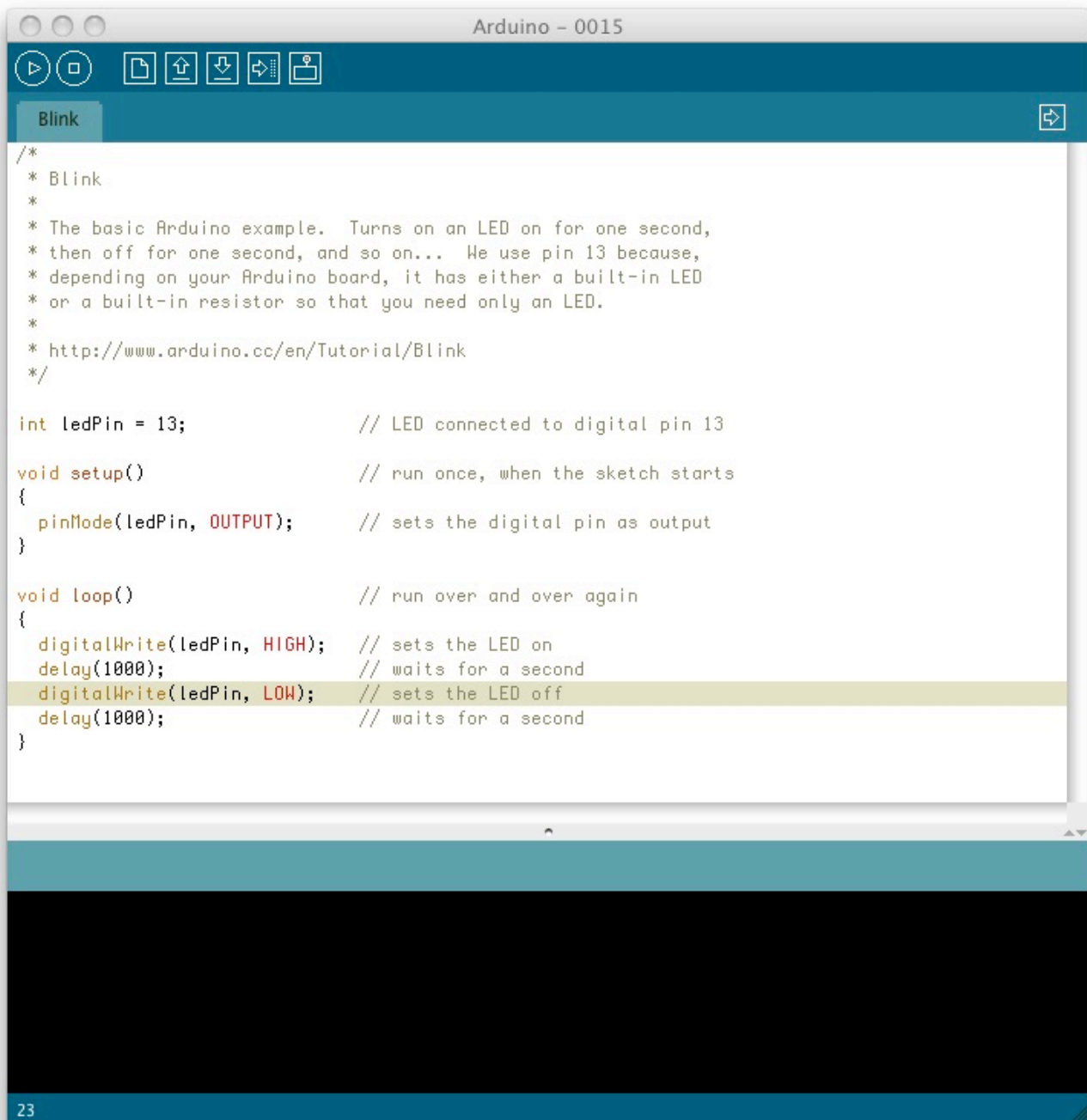

When you open up the Arduino IDE it will look very similar to the image above. If you are using Windows or Linux there will be some slight differences but the IDE is pretty much the same no matter what OS you are using.

The IDE is split up into the Toolbar across the top, the code or Sketch Window in the centre and the Serial Output window at the bottom.

The Toolbar consists of 7 buttons, underneath the Toolbar is a tab, or set of tabs, with the filename of the code within the tab. There is also one further button on the far right hand side.

Along the top is the file menu with drop down menus headed under File, Edit, Sketch, Tools and Help. The buttons in the Toolbar provide convenient access to the most commonly used functions within this file menu.



**Verify/  
Compile**

**Stop**

**New**

**Open**

**Save**

**Upload**

**Serial  
Monitor**

The Toolbar buttons are listed above. The functions of each button are as follows :-

<b>Verify/Compile</b>	Checks the code for errors
<b>Stop</b>	Stops the serial monitor, or un-highlights other buttons
<b>New</b>	Creates a new blank Sketch
<b>Open</b>	Shows a list of Sketches in your sketchbook
<b>Save</b>	Saves the current Sketch
<b>Upload</b>	Uploads the current Sketch to the Arduino
<b>Serial Monitor</b>	Displays serial data being sent from the Arduino

The **Verify/Compile** button is used to check that your code is correct, before you upload it to your Arduino.

The **Stop** button will stop the Serial Monitor from operating. It will also un-highlight other selected buttons. Whilst the Serial Monitor is operating you may wish to press the Stop button to obtain a ‘snapshot’ of the serial data so far to examine it. This is particularly useful if you are sending data out to the Serial Monitor quicker than you can read it.

The **New** button will create a completely new and blank Sketch read for you to enter code into. The IDE will ask you to enter a name and a location for your Sketch (try to use the default location if possible) and will then give you a blank Sketch ready to be coded. The tab at the top of the Sketch will now contain the name you have given to your new sketch.

The **Open** button will present you with a list of Sketches stored within your sketchbook as well as a list of Example sketches you can try out with various peripherals once connected.

The **Save** button will save the code within the sketch window to your sketch file. Once complete you will get a ‘Done Saving message at the bottom of the code window.

The **Upload to I/O Board** button will upload the code within the current sketch window to your Arduino. You need to make sure that you have the correct board and port selected (in the Tools menu) before uploading. It is essential that you Save your sketch before you upload it to your board in case a strange error causes your system to hang or the IDE to crash. It is also advisable to Verify/Compile the code before you upload to ensure there are no errors that need to be debugged first.

The **Serial Monitor** is a very useful tool, especially for debugging your code. The monitor displays serial data being sent out from your Arduino (USB or Serial board). You can also send serial data back to the Arduino using the Serial Monitor. If you click the Serial Monitor button you will be presented with an image like the one above.

On the left hand side you can select the Baud Rate that the serial data is to be sent to/from the Arduino. The Baud Rate is the rate, per second, that characters (data) is sent to/from the board. The default setting is 9600 baud, which means that if you were to send a text novel over the serial communications line (in this case your USB cable) then 9600 letters, or symbols, of the novel, would be sent per second.



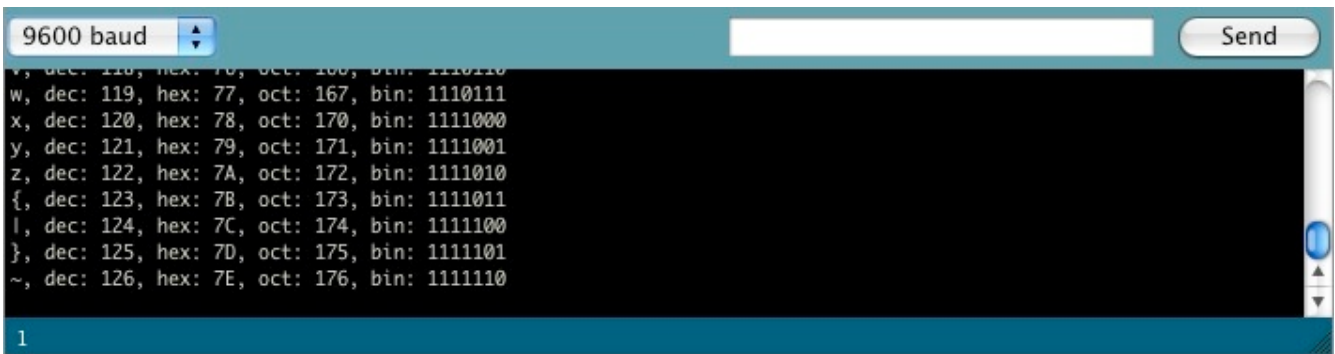

To the right of this is a blank text box for you to enter text to send back to the Arduino and a **Send** button to send the text within that field. Note that no serial data can be received by the Serial Monitor unless you have set up the code inside your sketch to do so. Similarly, the Arduino will not receive any data sent unless you have coded it to do so.

Finally, the black area is where your serial data will be displayed. In the image above, the Arduino is running the `ASCIITable` sketch, that can be found in the Communications examples. This program outputs ASCII characters, from the Arduino via serial (the USB cable) to the PC where the Serial monitor then displays them.

To start the Serial Monitor press the Serial Monitor button and to stop it press the Stop button. On a Mac or in Linux, Arduino board will reset itself (rerun the code from the beginning) when you click the Serial Monitor button.

Once you are proficient at communicating via serial to and from the Arduino you can use other programs such as Processing, Flash, MaxMSP, etc. To communicate between the Arduino and your PC.

We will make use of the Serial Monitor later on in our projects when we read data from sensors and get the Arduino to send that data to the Serial Monitor, in human readable form, for us to see.

The Serial Monitor window is also where you will see error messages (in red text) that the IDE will display to you when trying to connect to your board, upload code or verify code.

Below the Serial Monitor at the bottom left you will see a number. This is the current line that the cursor, within the code window, is at. If you have code in your window and you move down the lines of code (using the `↓` key on your keyboard) you will see the number increase as you move down the lines of code. This is useful for finding bugs highlighted by error messages.

Across the top of the IDE window (or across the top of your screen if you are using a Mac) you will see the various menus that you can click on to access more menu items.

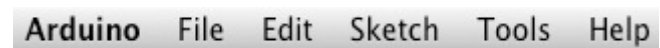

The menu bar across the top of the IDE looks like the image above (and slightly different in Windows and Linux). I will explain the menus as they are on a Mac, the details will also apply to the Windows and Linux versions of the IDE.

The first menu is the **Arduino menu**. Within this is the **About Arduino** option, which when pressed will show you the current version number, a list of the people involved in making this amazing device and some further information.



Underneath that is the **Preferences** option. This will bring up the Preferences window where you can change various IDE options, such as where your default Sketchbook is stored, etc.

Also, is the **Quit** option, which will Quit the program.

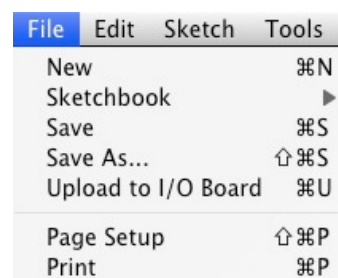

The next menu is the **File** menu. In here you get access to options to create a New sketch, take a look at Sketches stored in your Sketchbook (as well as the Example Sketches), options to Save your Sketch (or Save As if you want to give it a different name). You also have the option to upload your sketch to the I/O Board (Arduino) as well as the Print options for printing out your code.

Next is the **Edit** menu. In here you get options to enable you to Cut, Copy and Paste sections of code. Select All of your code as well as Find certain words or phrases within the code. Also included are the useful Undo and Redo options which come in handy when you make a mistake.

Edit	Sketch	Tools	Help
Undo			⌘Z
Redo			⌘Y
Cut			⌘X
Copy			⌘C
Paste			⌘V
Select All			⌘A
Find...			⌘F
Find Next			⌘G

Our next menu is the **Sketch** menu which gives us access to the Verify/Compile functions and some other

Sketch	Tools	Help
Verify/Compile		⌘R
Stop		
Import Library		▶
Show Sketch Folder		⌘K
Add File...		

useful functions you will use later on. These include the Import Library option, which when clicked will bring up a list of the available libraries, stored within your

libraries folder.

A Library, is a collection of code, that you can include in your sketch, to enhance the functionality of your project. It is a way of preventing you from 're-inventing the wheel' by reusing code already made by someone else for various pieces of common hardware you may encounter whilst using the Arduino.

For example, one of the libraries you will find is `Stepper`, which is a set of functions you can use within your code to control a Stepper Motor. Somebody else has kindly already created all of the necessary functions necessary to control a stepper motor and by including the Stepper library into our sketch we can use those functions to control the motor as we wish. By storing commonly used code in a library, you can re-use that code over and over in different projects and also hide the complicated parts of the code from the user.

We will go into greater detail concerning the use of libraries later on. Finally within the Sketch menu is the Show Sketch Menu option, which will open up the folder where your Sketch is stored. Also, there is the Add File option which will enable you to add another source file to your Sketch. This functionality allows you to split larger sketches into smaller files and then Add them to the main Sketch.

The next menu in the IDE is the **Tools** menu. Within this are the options to select the Board and Serial Port we are using, as we did when setting up the Arduino for the first time. Also we have the Auto Format function that formats your code to make it look nicer.

Tools	Help
Auto Format	⌘T
Copy for Forum	
Archive Sketch	
Board	▶
Serial Port	▶
Burn Bootloader	▶

The Copy for Forum option will copy the code within the Sketch window, but in a format that when pasted into the Arduino forum (or most other Forums for that matter) will show up the same as it is in the IDE, along with syntax colouring, etc.

The Archive Sketch option will enable you to compress your sketch into a ZIP file and asks you where you want to store it.

Finally, the Burn Bootloader option can be used to burn the Arduino Bootloader (piece of code on the chip to make it compatible with the Arduino IDE) to the chip. This option can only be used if you have an AVR programmer and have replaced the chip in your Arduino or have bought blank chips to use in your own embedded project. Unless you plan on burning lots of chips it is usually cheaper and easier to just buy an ATmega chip with the Arduino Bootloader already pre-programmed. Many online stores stock pre-programmed chips and obviously these can be found in the [Earthshine Design store](#).

The final menu is the **Help** menu where you can find help menus for finding out more information about the IDE or links to the reference pages of the Arduino website and other useful pages.

Don't worry too much about using the IDE for now as you will pick up the important concepts and how to use it properly as we work our way through the projects. So, on that note, let's get on with it.

# Earthshine Design

Arduino Starters Kit Manual

A Complete Beginners guide to the Arduino

# The Projects





# Project 1

## LED Flasher

# Project 1 - LED Flasher

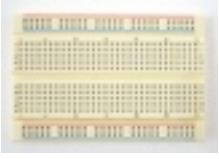
In this project we are going to repeat what we did in setting up and testing the Arduino, that is to blink an LED. However, this time we are going to use one of the LEDs in the kit and you will also learn about some electronics and coding in C along the way.

## What you will need

Breadboard	
Red LED	
150Ω Resistor	
Jumper Wires	

It doesn't matter if you use different coloured wires or use different holes on the breadboard as long as the components and wires are connected in the same order as the picture. Be careful when inserting components into the Breadboard. The Breadboard is brand new and the grips in the holes will be stiff to begin with. Failure to insert components carefully could result in damage.

Make sure that your LED is connected the right way with the longer leg connected to Digital Pin 10. The long leg is the Anode of the LED and always must go to the +5v supply (in this case coming out of Digital Pin 10) and the short leg is the Cathode and must go to Gnd (Ground).

When you are happy that everything is connected up correctly, power up your Arduino and connect the USB cable.

## Enter the code

Now, open up the Arduino IDE and type in the following code :-

```
// Project 1 - LED Flasher

int ledPin = 10;

void setup() {
    pinMode(ledPin, OUTPUT);
}

void loop() {
    digitalWrite(ledPin, HIGH);
    delay(1000);
    digitalWrite(ledPin, LOW);
    delay(1000);
}
```

## Connect it up

Now, first make sure that your Arduino is powered off. You can do this either by unplugging the USB cable or by taking out the Power Selector Jumper on the Arduino board. Then connect everything up like this :-

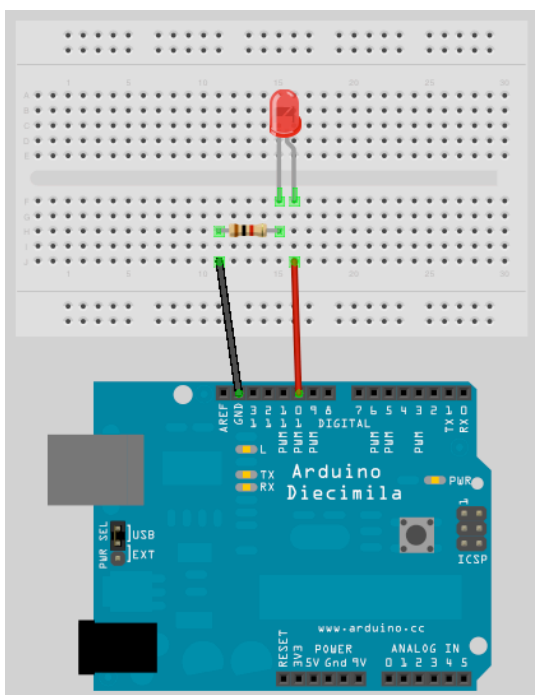

Now press the Verify/Compile button at the top of the IDE to make sure there are no errors in your code. If this is successful you can now click the Upload button to upload the code to your Arduino.

If you have done everything right you should now see the Red LED on the breadboard flashing on and off every second.

Now let's take a look at the code and the hardware and find out how they both work.

# Project 1 – Code Overview

```
// Project 1 - LED Flasher

int ledPin = 10;

void setup() {
    pinMode(ledPin, OUTPUT);
}

void loop() {
    digitalWrite(ledPin, HIGH);
    delay(1000);
    digitalWrite(ledPin, LOW);
    delay(1000);
}
```

So let's take a look at the code for this project. Our first line is

```
// Project 1 - LED Flasher
```

This is simply a comment in your code and is ignored by the compiler (the part of the IDE that turns your code into instructions the Arduino can understand before uploading it). Any text entered behind a `//` command will be ignored by the compiler and is simply there for you, or anyone else that reads your code. Comments are essential in your code to help you understand what is going on and how your code works. Comments can also be put after commands as in the next line of the program.

Later on as your projects get more complex and your code expands into hundreds or maybe thousands of lines, comments will be vital in making it easy for you to see how it works. You may come up with an amazing piece of code, but if you go back and look at that code days, weeks or months later, you may forget how it all works. Comments will help you understand it easily. Also, if your code is meant to be seen by other people (and as the whole ethos of the Arduino, and indeed the whole Open Source, community is to share code and schematics, we hope when you start making your own cool stuff with the Arduino you will be willing to share it with the world) then comments will enable that person to understand what is going on in your code.

You can also put comments into a block statement by using the `/*` and `*/` commands. E.g.

```
/* All of the text within
the slash and the asterisks
is a comment and will be
ignored by the compiler */
```

The IDE will automatically turn the colour of any commented text to grey.

The next line of the program is

```
int ledPin = 10;
```

This is what is known as a variable. A variable is a place to store data. In this case you are setting up a variable of type `int` or integer. An integer is a number within the range of -32,768 to 32,767. Next you have assigned that integer the name of `ledPin` and have given it a value of 10. We didn't have to call it `ledPin`, we could have called it anything we wanted to. But, as we want our variable name to be descriptive we call it `ledPin` to show that the use of this variable is to set which pin on the Arduino we are going to use to connect our LED. In this case we are using Digital Pin 10. At the end of this statement is a semi-colon. This is a symbol to tell the compiler that this statement is now complete.

Although we can call our variables anything we want, every variable name in C must start with a letter, the rest of the name can consist of letters, numbers and underscore characters. C recognises upper and lower case characters as being different. Finally, you cannot use any of C's keywords like `main`, `while`, `switch` etc as variable names. [Keywords](#) are constants, variables and function names that are defined as part of the Arduino language. Don't use a variable name that is the same as a keyword. All keywords within the sketch will appear in red.

So, you have set up an area in memory to store a number of type integer and have stored in that area the number 10. Imagine a variable as a small box where you can keep things. A variable is called a variable because you can change it. Later on we will carry out mathematical calculations on variables to make our program do more advanced stuff.

Next we have our `setup()` function

```
void setup() {
    pinMode(ledPin, OUTPUT);
}
```

An Arduino sketch must have a `setup()` and `loop()` function otherwise it will not work. The `setup()` function is run once and once only at the start of the program and is where you will do issue general instructions to prepare the program before the main loop runs, such as setting up pin modes, setting serial baud rates, etc.

Basically a function is a block of code assembled into one convenient block. For example, if we created our own function to carry out a whole series of complicated mathematics that had many lines of code, we could run that code as many times as we liked simply by calling the function name instead of writing

## Anatomy of a C function

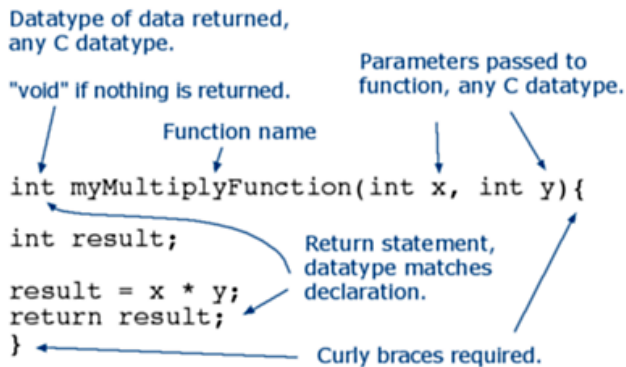

out the code again each time. Later on we will go into functions in more detail when we start to create our own.

In the case of our program the `setup()` function only has one statement to carry out. The function starts with

```
void setup()
```

and here we are telling the compiler that our function is called `setup`, that it returns no data (`void`) and that we pass no parameters to it (empty parenthesis). If our function returned an integer value and we also had integer values to pass to it (e.g. for the function to process) then it would look something like this

```
int myFunc(int x, int y)
```

In this case we have created a function (or a block of code) called `myFunc`. This function has been passed two integers called `X` and `Y`. Once the function has finished it will then return an integer value to the point after where our function was called in the program (hence `int` before the function name).

All of the code within the function is contained within the curly braces. A `{` symbol starts the block of code and a `}` symbol ends the block. Anything in between those two symbols is code that belongs to the function.

We will go into greater detail about functions later on so don't worry about them for now. All you need to know is that in this program, we have two functions, the first function is called `setup` and its purpose is to setup anything necessary for our program to work before the main program loop runs.

```
void setup() {
    pinMode(ledPin, OUTPUT);
}
```

Our `setup` function only has one statement and that is `pinMode`. Here we are telling the Arduino that we want to set the mode of one of our digital pins to be Output mode, rather than Input. Within the parenthesis we put the pin number and the mode (`OUTPUT` or `INPUT`). Our pin number is `ledPin`, which has been previously set to the value 10 in our program. Therefore, this statement is simply telling the Arduino that the Digital Pin 10 is to be set to `OUTPUT` mode.

As the `setup()` function runs only once, we now move onto the main function loop.

```
void loop() {
    digitalWrite(ledPin, HIGH);
    delay(1000);
    digitalWrite(ledPin, LOW);
    delay(1000);
}
```

The `loop()` function is the main program function and runs continuously as long as our Arduino is turned on. Every statement within the `loop()` function (within the curly braces) is carried out, one by one, step by step, until the bottom of the function is reached, then the loop starts again at the top of the function, and so on forever or until you turn the Arduino off or press the Reset switch.

In this project we want the LED to turn on, stay on for one second, turn off and remain off for one second, and then repeat. Therefore, the commands to tell the Arduino to do that are contained within the `loop()` function as we wish them to repeat over and over.

The first statement is

```
digitalWrite(ledPin, HIGH);
```

and this writes a `HIGH` or a `LOW` value to the digital pin within the statement (in this case `ledPin`, which is Digital Pin 10). When you set a digital pin to `HIGH` you are sending out 5 volts to that pin. When you set it to `LOW` the pin becomes 0 volts, or Ground.

This statement therefore sends out 5v to digital pin 10 and turns the LED on.

After that is

```
delay(1000);
```

and this statement simply tells the ARduino to wait for 1000 milliseconds (to 1 second as there are 1000 milliseconds in a second) before carrying out the next statement which is

```
digitalWrite(ledPin, LOW);
```

which will turn off the power going to digital pin 10 and therefore turn the LED off. There is then another delay statement for another 1000 milliseconds and then the function ends. However, as this is our main loop() function, the function will now start again at the beginning. By following the program structure step by step again we can see that it is very simple.

```
// Project 1 - LED Flasher

int ledPin = 10;

void setup() {
  pinMode(ledPin, OUTPUT);
}

void loop() {
  digitalWrite(ledPin, HIGH);
  delay(1000);
  digitalWrite(ledPin, LOW);
  delay(1000);
}
```

We start off by assigning a variable called ledPin, giving that variable a value of 10.

Then we move onto the setup() function where we simply set the mode for digital pin 10 as an output.

In the main program loop we set Digital Pin 10 to high, sending out 5v. Then we wait for a second and then turn off the 5v to Pin 10, before waiting another second. The loop then starts again at the beginning and the LED will therefore turn on and off continuously for as long as the Arduino has power.

Now that you know this you can modify the code to turn the LED on for a different period of time and also turn it off for a different time period.

For example, if we wanted the LED to stay on for 2 seconds, then go off for half a second we could do this:-

```
void loop() {
  digitalWrite(ledPin, HIGH);
  delay(2000);
  digitalWrite(ledPin, LOW);
  delay(500);
}
```

or maybe you would like the LED to stay off for 5 seconds and then flash briefly (250ms), like the LED indicator on a car alarm then you could do this:-

```
void loop() {
  digitalWrite(ledPin, HIGH);
  delay(250);
  digitalWrite(ledPin, LOW);
  delay(5000);
}
```

or make the LED flash on and off very fast

```
void loop() {
  digitalWrite(ledPin, HIGH);
  delay(50);
  digitalWrite(ledPin, LOW);
  delay(50);
}
```





By varying the on and off times of the LED you create any effect you want. Well, within the bounds of a single LED going on and off that is.

Before we move onto something a little more exciting let's take a look at the hardware and see how it works.



# Project 1 – Hardware Overview

The hardware used for this project was :-

Breadboard	
Red LED	
150Ω Resistor	
Jumper Wires	

The breadboard is a reusable solderless device used generally to prototype an electronic circuit or for experimenting with circuit designs. The board consists of a series of holes in a grid and underneath the board these holes are connected by a strip of conductive metal. The way those strips are laid out is typically something like this:-

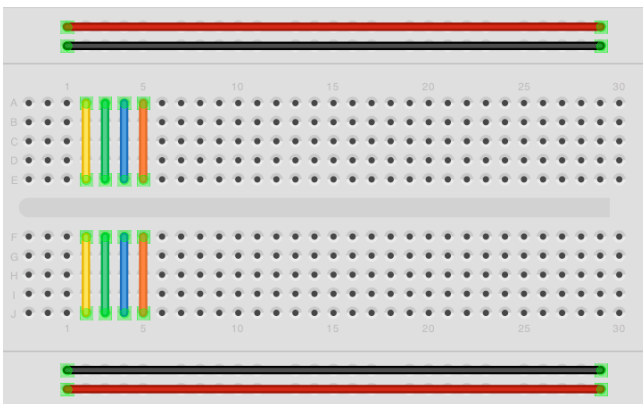

The strips along the top and bottom run parallel to the board and are design to carry your power rail and your ground rail. The components in the middle of the board can then conveniently connect to either 5v (or whatever voltage you are using) and Ground. Some breadboards have a red and a black line running parallel to these holes to show which is power (Red) and which is Ground (Black). On larger breadboards the power rail sometimes has a split, indicated by a break in the red line. This is in case you want different voltages to go to different parts of your board. If you are using just one voltage a short piece of jumper wire can be placed across this gap to make sure that the same voltage is applied along the whole length of the rail

The strips in the centre run at 90 degrees to the power and ground rails in short lengths and there is a gap in the middle to allow you to put Integrated Circuits across the gap and have each pin of the chip go to a different set of holes and therefore a different rail.

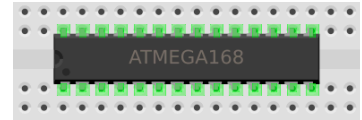

The next component we have is a [Resistor](#). A resistor is a device designed to cause 'resistance' to an electric current and therefore cause a drop in voltage across it's terminals. If you imagine a resistor to be like a water pipe that is a lot thinner than the pipe connected to it. As the water (the electric current) comes into the resistor, the pipe gets thinner and the current coming out of the other end is therefore reduced. We use resistors to decrease voltage or current to other devices. The value of resistance is known as an Ohm and it's symbol is a greek Omega symbol  $\Omega$ .

In this case Digital Pin 10 is outputting 5 volts DC at (according to the Atmega datasheet) 40mA (milliamps) and our LED's require (according to their datasheet) a voltage of 2v and a current of 20mA. We therefore need to put in a resistor that will reduce the 5v to 2v and the current from 40mA to 20mA if we want to display the LED at it's maximum brightness. If we want the LED to be dimmer we could use a higher value of resistance.

To work out what resistor we need to do this we use what is called [Ohm's law](#) which is  $I = V/R$  where I is current, V is voltage and R is resistance. So to work out the resistance we arrange the formula to be  $R = V/I$  which is  $R = 3/0.02$  which is 100 Ohms. V is 3 because we need the Voltage Drop, which is the supply voltage (5v) minus the Forward Voltage (2v) of the LED (found in the LED datasheet) which is 3v. We therefore need to find a 150 $\Omega$  resistor. So how do we do that?

A resistor is too small to put writing onto that could be readable by most people so instead resistors use a colour code. Around the resistor you will typically find 4 coloured bands and by using the colour code in the chart on the next page you can find out the value of a resistor or what colour codes a particular resistance will be.

**WARNING:**  
Always put a resistor (commonly known as a current limiting resistor) in series with an LED. If you fail to do this you will supply too much current to the LED and it could blow or damage your circuit.

Colour	1 <sup>st</sup> Band	2 <sup>nd</sup> Band	3 <sup>rd</sup> Band (multiplier)	4 <sup>th</sup> Band (tolerance)
Black	0	0	$\times 10^0$	
Brown	1	1	$\times 10^1$	$\pm 1\%$
Red	2	2	$\times 10^2$	$\pm 2\%$
Orange	3	3	$\times 10^3$	
Yellow	4	4	$\times 10^4$	
Green	5	5	$\times 10^5$	$\pm 0.5\%$
Blue	6	6	$\times 10^6$	$\pm 0.25\%$
Violet	7	7	$\times 10^7$	$\pm 0.1\%$
Grey	8	8	$\times 10^8$	$\pm 0.05\%$
White	9	9	$\times 10^9$	
Gold			$\times 10^{-1}$	$\pm 5\%$
Silver			$\times 10^{-2}$	$\pm 10\%$
None				$\pm 20\%$

We need a 150Ω resistor, so if we look at the colour table we see that we need 1 in the first band, which is Brown, followed by a 5 in the next band which is Green and we then need to multiply this by 10<sup>1</sup> (in other words add 1 zero) which is Brown in the 3<sup>rd</sup> band. The final band is irrelevant for our purposes as this is the tolerance. Our resistor has a gold band and therefore has a tolerance of ±5% which means the actual value of the resistor can vary between 142.5Ω and 157.5Ω. We therefore need a resistor with a Brown, Green, Brown, Gold colour band combination which looks like this:-



If we needed a 1K (or 1 kilo-ohm) resistor we would need a Brown, Black, Red combination (1, 0, +2 zeros). If we needed a 570K resistor the colours would be Green, Violet and Yellow.

In the same way, if you found a resistor and wanted to know what value it is you would do the same in reverse. So if you found this resistor and wanted to find out what value it was so you could store it away in your nicely labelled resistor storage box, we could look at the table to see it has a value of 220Ω.

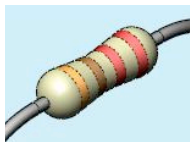

Our final component is an LED (I'm sure you can figure out what the jumper wires do for yourself), which stands for Light Emitting Diode. A [Diode](#) is a device that permits current to flow in only one direction. So, it is just like a valve in a water system, but in this case it is letting electrical current to go in one direction, but if the current tried to reverse and go back in the opposite direction the diode would stop it from doing so. Diodes can be useful to prevent someone from accidentally connecting the Power and Ground to the wrong terminals in a circuit and damaging the components.

An [LED](#) is the same thing, but it also emits light. LED's come in all kinds of different colours and brightnesses and can also emit light in the ultraviolet and infrared part of the spectrum (like in the LED's in your TV remote control).

If you look carefully at the LED you will notice two things. One is that the legs are of different lengths and also that on one side of the LED, instead of it being cylindrical, it is flattened. These are indicators to show you which leg is the Anode (Positive) and which is the Cathode (Negative). The longer leg gets connected to the Positive Supply (5v) and the leg with the flattened side goes to Ground.

If you connect the LED the wrong way, it will not damage it (unless you put very high currents through it) and indeed you can make use of that 'feature' as we will see later on.

It is essential that you always put a resistor in series with the LED to ensure that the correct current gets to the LED. You can permanently damage the LED if you fail to do this.

As well as single colour resistors you can also obtain bi-colour and tri-colour LED's. These will have several legs coming out of them with one of them being common (i.e. Common anode or common cathode).

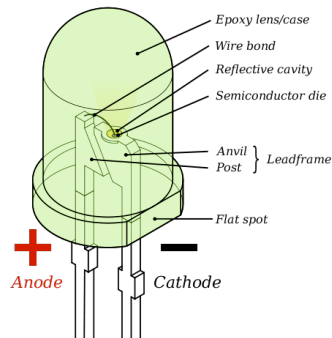

Supplied with your kit is an RGB LED, which is 3 LED's in a single package. An RGB LED has a Red, Green and a Blue (hence RGB) LED in one package. The LED has 4 legs, one will be a common anode or cathode, common to all 3 LED's and the other 3 will then go to the anode or cathode of the individual Red, Green and Blue LED's. By adjusting the brightness values of the R, G and B channels of the RGB LED you can get any colour you want. The same effect can be obtained if you used 3 separate red, green and blue LED's.

Now that you know how the components work and how the code in this project works, let's try something a bit more interesting.

# Project 2

S.O.S. Morse Code Signaler

# Project 2 - SOS Morse Code Signaler

## What you will need

For this project we are going to leave the exact same circuit set up as in Project 1, but will use some different code to make the LED display a message in Morse Code. In this case, we are going to get the LED to signal the letters S.O.S., which is the international morse code distress signal. [Morse Code](#) is a type of character encoding that transmits letters and numbers using patterns of On and Off. It is therefore nicely suited to our digital system as we can turn an LED on and off in the necessary pattern to spell out a word or a series of characters. In this case we will be signaling [S.O.S.](#) which in the Morse Code alphabet is three dits (short flash), followed by three dahs (long flash), followed by three dits again.

We can therefore now code our sketch to flash the LED on and off in this pattern, signaling SOS.

## Enter the code

Create a new sketch and then type in the code listed above. Verify your code is error free and then upload it to your Arduino.

If all goes well you will now see the LED flash the Morse Code SOS signal, wait 5 seconds, then repeat.

If you were to rig up a battery operated Arduino to a very bright light and then place the whole assembly into a waterproof and handheld box, this code could be used to control an SOS emergency strobe light to be used on boats, whilst mountain climbing, etc.

So, let's take a look at this code and work out how it works.

```
// Project 2 - SOS Morse Code Signaler

// LED connected to digital pin 10
int ledPin = 10;

// run once, when the sketch starts
void setup()
{
  // sets the digital pin as output
  pinMode(ledPin, OUTPUT);
}

// run over and over again
void loop()
{
  // 3 dits
  for (int x=0; x<3; x++) {
    digitalWrite(ledPin, HIGH); // sets the LED on
    delay(150); // waits for 150ms
    digitalWrite(ledPin, LOW); // sets the LED off
    delay(100); // waits for 100ms
  }

  // 100ms delay to cause slight gap between letters
  delay(100);
  // 3 dahs
  for (int x=0; x<3; x++) {
    digitalWrite(ledPin, HIGH); // sets the LED on
    delay(400); // waits for 400ms
    digitalWrite(ledPin, LOW); // sets the LED off
    delay(100); // waits for 100ms
  }

  // 100ms delay to cause slight gap between letters
  delay(100);

  // 3 dits again
  for (int x=0; x<3; x++) {
    digitalWrite(ledPin, HIGH); // sets the LED on
    delay(150); // waits for 150ms
    digitalWrite(ledPin, LOW); // sets the LED off
    delay(100); // waits for 100ms
  }

  // wait 5 seconds before repeating the SOS signal
  delay(5000);
}
```



# Project 2 - Code Overview

So the first part of the code is identical to the last project where we initialise a variable and then set pin 10 to be an output. In the main code loop we can see the same kind of statements to turn the LED's on and off for a set period of time, but this time the statements are within 3 separate code blocks.

The first block is what outputs the 3 dits

```
for (int x=0; x<3; x++) {
digitalWrite(ledPin, HIGH);
delay(150);
digitalWrite(ledPin, LOW);
delay(100);
}
```

We can see that the LED is turned on for 150ms and then off for 100ms and we can see that those statements are within a set of curly braces and are therefore in a separate code block. But, when we run the sketch we can see the light flashes 3 times not just once.

This is done using the for loop.

```
for (int x=0; x<3; x++) {
```

This statement is what makes the code within it's code block execute 3 times. There are 3 parameters we need to give to the for loop. These are initialisation, condition, increment. The **initialisation** happens first and exactly once. Each time through the loop, the **condition** is tested; if it's true, the statement block, and the **increment** is executed, then the **condition** is tested again. When the **condition** becomes false, the loop ends.

So, first we need to initialise a variable to be the start number of the loop. In this case we set up variable X and set it to zero.

```
int x=0;
```

We then set a condition to decide how many times the code in the loop will execute.

```
x<3;
```

In this case the code will loop if X is smaller than (<) 3. The code within a for loop will always execute once no matter what the condition is set to.

The < symbol is what is known as a 'comparison operator'. They are used to make decisions within your code and to compare two values. The symbols used are:-

```
== (equal to)
!= (not equal to)
< (less than)
> (greater than)
<= (less than or equal to)
>= (greater than or equal to)
```

In our code we are comparing x with the value of 3 to see if it is smaller than 3. If x is smaller than 3, then the code in the block will repeat again.

The final statement is

```
x++
```

this is a statement to increase the value of x by 1. We could also have typed in `x = x + 1;` which would assign to x the value of x + 1. Note there is no need to put a semi-colon after this final statement in the for loop.

You can do simple mathematics using the symbols +, -, \* and / (addition, subtraction, multiplication and division). E.g.

```
1 + 1 = 2
3 - 2 = 1
2 * 4 = 8
8 / 2 = 4
```

So, our for loop initialises the value of x to 3, then runs the code within the block (curly braces). It then increases the increment, in this case adds 1 to x. Finally it then checks that the condition is met, which is that x is smaller than 3 and if so repeats.

So, now we know how the for loop works, we can see in our code that there are 3 for loops, one that loops 3 times and displays the 'dits', the next one repeats 3 times and displays the 'dahs', then there is a repeat of the dit's again.

It must be noted that the variable x has a local 'scope', which means it can only be seen by the code within it's own code block. Unless you initialise it before the setup() function in which case it has 'global scope' and can be seen by the entire program. If you try to access x outside the for loop you will get an error.

In between each for loop there is a small delay to make a tiny visible pause between letters of SOS. Finally, the code waits for 5 seconds before the main program loop starts again from the beginning.

OK now let's move onto using multiple LED's.

# Project 3

## Traffic Lights

# Project 3 - Traffic Lights

We are now going to create a set of UK traffic lights that will change from green to red, via amber, and back again, after a set length of time using the 4-state system. This project could be used on a model railway to make a set of working traffic lights or for a child's toy town.

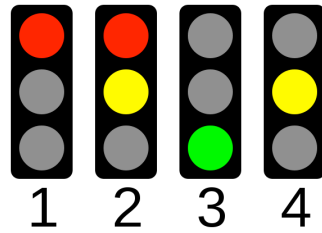

This time we have connected 3 LED's with the Anode of each one going to Digital Pins 8, 9 and 10, via a 150Ω resistor each.

We have taken a jumper wire from Ground to the Ground rail at the top of the breadboard and a ground wire goes from the Cathode leg of each LED to the common ground rail.

## What you will need

Breadboard	
Red Diffused LED	
Yellow Diffused LED	
Green Diffused LED	
3 x 220Ω Resistors	
Jumper Wires	

## Enter the code

Enter the following code, check it and upload.

If you've read up on Projects 1 & 2 then this code will be self explanatory as will the hardware.

```
// Project 3 - Traffic Lights

int ledDelay = 10000; // delay in between changes
int redPin = 10;
int yellowPin = 9;
int greenPin = 8;

void setup() {
  pinMode(redPin, OUTPUT);
  pinMode(yellowPin, OUTPUT);
  pinMode(greenPin, OUTPUT);
}

void loop() {

  // turn the red light on
  digitalWrite(redPin, HIGH);
  delay(ledDelay); // wait 5 seconds

  digitalWrite(yellowPin, HIGH); // turn on yellow
  delay(2000); // wait 2 seconds

  digitalWrite(greenPin, HIGH); // turn green on
  digitalWrite(redPin, LOW); // turn red off
  digitalWrite(yellowPin, LOW); // turn yellow off
  delay(ledDelay); // wait ledDelay milliseconds

  digitalWrite(yellowPin, HIGH); // turn yellow on
  digitalWrite(greenPin, LOW); // turn green off
  delay(2000); // wait 2 seconds

  digitalWrite(yellowPin, LOW); // turn yellow off
  // now our loop repeats
}
```

## Connect it up

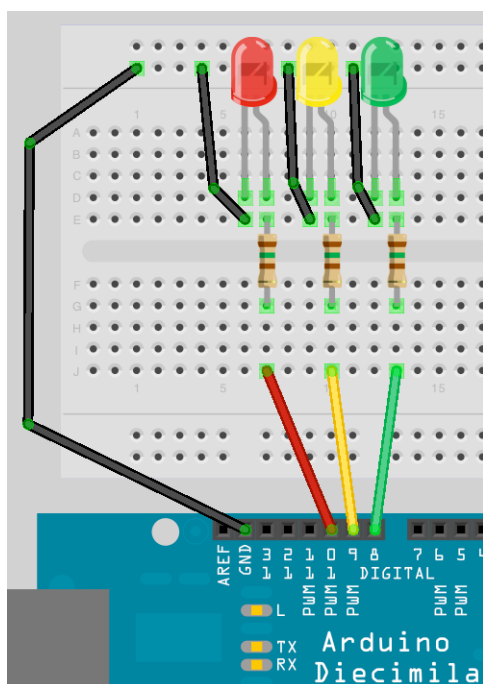

In the next project, we are going add to this project by including a set of pedestrian lights and adding a push button to make the lights interactive.



# Project 4

## Interactive Traffic Lights

# Project 4 - Interactive Traffic Lights

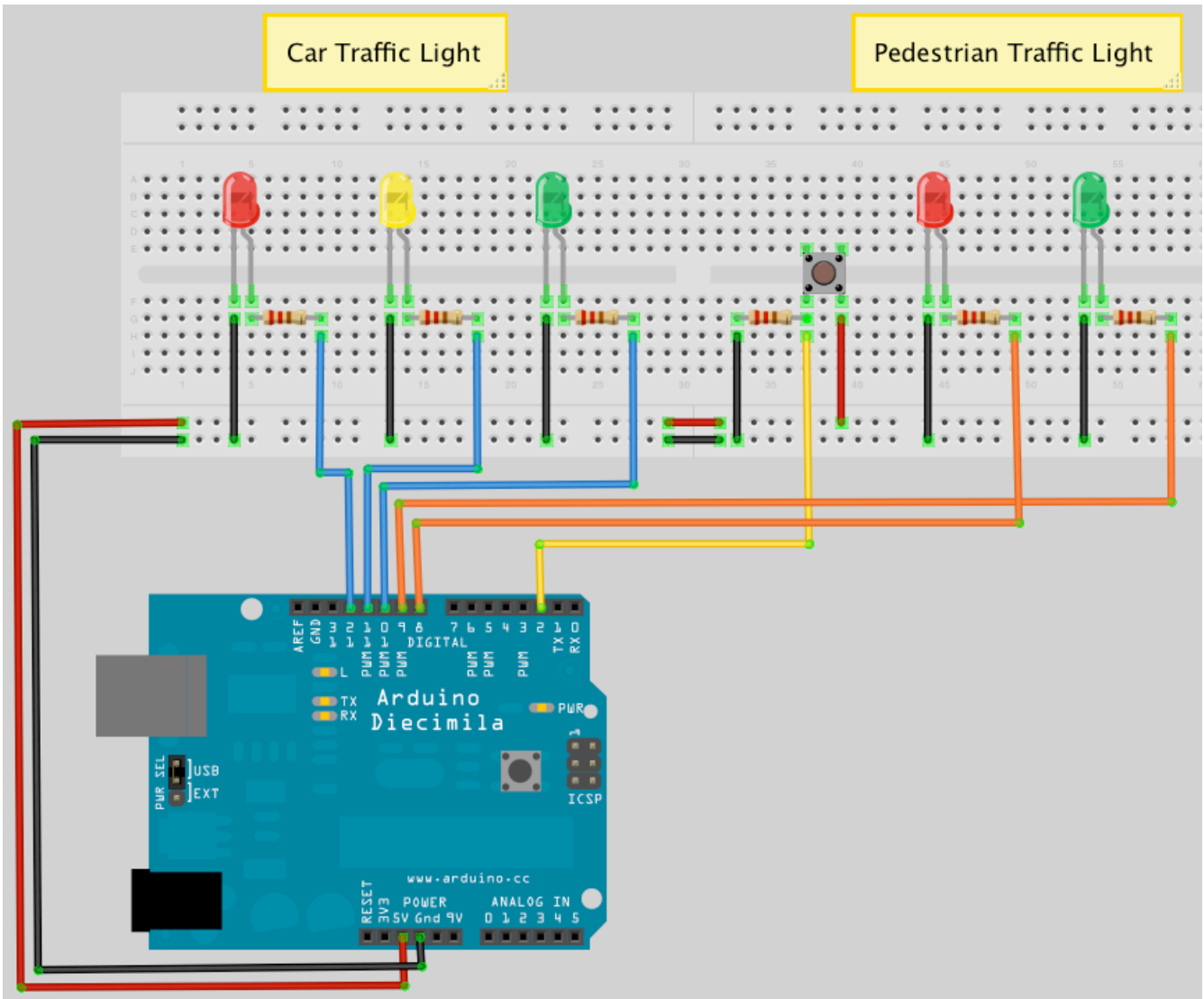

This time we are going to extend the previous project to include a set of pedestrian lights and a pedestrian push button to request to cross the road. The Arduino will react when the button is pressed by changing the state of the lights to make the cars stop and allow the pedestrian to cross safely.

For the first time we are able to interact with the Arduino and cause it to do something when we change the state of a button that the Arduino is watching (i.e. Press it to change the state from open to closed). In this project we will also learn how to create our own functions.

From now on when connecting the components we will no longer list the breadboard and jumper wires. Just take it as read that you will always need both of those.

## What you will need

2 x Red Diffused LED's	
Yellow Diffused LED	
2 x Green Diffused LED's	
5 x 150Ω Resistors	
Tactile Switch	

## Connect it up

Connect the LED's and the switch up as in the diagram on the previous page. You will need to shuffle the wires along from pins 8, 9 and 10 in the previous project to pins 10, 11 and 12 to allow you to connect the pedestrian lights to pins 8 and 9.

## Enter the code

Enter the code on the next page, verify and upload it.

When you run the program you will see that the car traffic light starts on green to allow cars to pass and the pedestrian light is on red.

When you press the button, the program checks that at least 5 seconds have gone by since the last time the lights were changed (to allow traffic to get moving),

and if so passes code execution to the function we have created called `changeLights()`. In this function the car lights go from green to amber then red, then the pedestrian lights go green. After a period of time set in the variable `crossTime` (time enough to allow the pedestrians to cross) the green pedestrian light will flash on and off as a warning to the pedestrians to get a hurry on as the lights are about to change back to red. Then the pedestrian light changes back to red and the vehicle lights go from red to amber to green and the traffic can resume.

The code in this project is similar to the previous project. However, there are a few new statements and concepts that have been introduced so let's take a look at those.

```

// Project 4 - Interactive Traffic Lights

int carRed = 12; // assign the car lights
int carYellow = 11;
int carGreen = 10;
int pedRed = 9; // assign the pedestrian lights
int pedGreen = 8;
int button = 2; // button pin
int crossTime = 5000; // time allowed to cross
unsigned long changeTime; // time since button pressed

void setup() {
  pinMode(carRed, OUTPUT);
  pinMode(carYellow, OUTPUT);
  pinMode(carGreen, OUTPUT);
  pinMode(pedRed, OUTPUT);
  pinMode(pedGreen, OUTPUT);
  pinMode(button, INPUT); // button on pin 2
  // turn on the green light
  digitalWrite(carGreen, HIGH);
  digitalWrite(pedRed, HIGH);
}

void loop() {
  int state = digitalRead(button);
  /* check if button is pressed and it is
  over 5 seconds since last button press */
  if (state == HIGH && (millis() - changeTime) > 5000) {
    // Call the function to change the lights
    changeLights();
  }
}

void changeLights() {
  digitalWrite(carGreen, LOW); // green off
  digitalWrite(carYellow, HIGH); // yellow on
  delay(2000); // wait 2 seconds

  digitalWrite(carYellow, LOW); // yellow off
  digitalWrite(carRed, HIGH); // red on
  delay(1000); // wait 1 second till its safe

  digitalWrite(pedRed, LOW); // ped red off
  digitalWrite(pedGreen, HIGH); // ped green on
  delay(crossTime); // wait for preset time period

  // flash the ped green
  for (int x=0; x<10; x++) {
    digitalWrite(pedGreen, HIGH);
    delay(250);
    digitalWrite(pedGreen, LOW);
    delay(250);
  }
  // turn ped red on
  digitalWrite(pedRed, HIGH);
  delay(500);

  digitalWrite(carYellow, HIGH); // yellow on
  digitalWrite(carRed, LOW); // red off
  delay(1000);
  digitalWrite(carGreen, HIGH);
  digitalWrite(carYellow, LOW); // yellow off

  // record the time since last change of lights
  changeTime = millis();
  // then return to the main program loop
}

```

# Project 4 – Code Overview

Most of the code in this project you will understand and recognise from previous projects. However, let us take a look at a few new keywords and concepts that have been introduced in this sketch.

```
unsigned long changeTime;
```

Here we have a new data type for a variable. Previously we have created integer data types, which can store a number between -32,768 and 32,767. This time we have created a data type of long, which can store a number from -2,147,483,648 to 2,147,483,647. However, we have specified an unsigned long, which means the variable cannot store negative numbers, which gives us a range from 0 to 4,294,967,295. If we were to use an integer to store the length of time since the last change of lights, we would only get a maximum time of 32 seconds before the integer variable reached a number higher than it could store.

As a pedestrian crossing is unlikely to be used every 32 seconds we don't want our program crashing due to our variable 'overflowing' when it tries to store a number too high for the variable data type. That is why we use an unsigned long data type as we now get a huge length of time in between button presses.

**4294967295 \* 1ms = 4294967 seconds**  
**4294967 seconds = 71582 minutes**  
**71582 minutes - 1193 hours**  
**1193 hours - 49 days**

As it is pretty inevitable that a pedestrian crossing will get it's button pressed at least once in 49 days we shouldn't have a problem with this data type.

You may well ask why we don't just have one data type that can store huge numbers all the time and be done with it. Well, the reason we don't do that is because variables take up space in memory and the larger the number the more memory is used up for storing variables. On your home PC or laptop you won't have to worry about that much at all, but on a small microcontroller like the Atmega328 that the Arduino uses it is essential that we use only the smallest variable data type necessary for our purpose.

There are various data types that we can use as our sketches and these are:-

Data type	RAM	Number Range
<a href="#">void keyword</a>	N/A	N/A
<a href="#">boolean</a>	1 byte	0 to 1 (True or False)
<a href="#">byte</a>	1 byte	0 to 255
<a href="#">char</a>	1 byte	-128 to 127
<a href="#">unsigned char</a>	1 byte	0 to 255
<a href="#">int</a>	2 byte	-32,768 to 32,767
<a href="#">unsigned int</a>	2 byte	0 to 65,535
<a href="#">word</a>	2 byte	0 to 65,535
<a href="#">long</a>	4 byte	-2,147,483,648 to 2,147,483,647
<a href="#">unsigned long</a>	4 byte	0 to 4,294,967,295
<a href="#">float</a>	4 byte	-3.4028235E+38 to 3.4028235E+38
<a href="#">double</a>	4 byte	-3.4028235E+38 to 3.4028235E+38
<a href="#">string</a>	1 byte + x	Arrays of chars
<a href="#">array</a>	1 byte + x	Collection of variables

Each data type uses up a certain amount of memory on the Arduino as you can see on the chart above. Some variables use only 1 byte of memory and others use 4 or more (don't worry about what a byte is for now as we will discuss this later). You can not copy data from one data type to another, e.g. If x was an int and y was a string then x = y would not work as the two data types are different.

The Atmega168 has 1Kb (1000 bytes) and the Atmega328 has 2Kb (2000 bytes) of SRAM. This is not a lot and in large programs with lots of variables you could easily run out of memory if you do not optimise your usage of the correct data types. From the list above we can clearly see that our use of the int data type is wasteful as it uses up 2 bytes and can store a number up to 32,767. As we have used int to store the number of our digital pin, which will only go as high as 13 on our Arduino (and up to 54 on the Arduino Mega), we have used up more memory than was necessary. We could have saved memory by using the byte data type, which can store a number between 0 and 255, which is more than enough to store the number of an I/O pin.

Next we have

```
pinMode(button, INPUT);
```

This tells the Arduino that we want to use Digital Pin 2 (button = 2) as in INPUT. We are going to use pin 2 to listen for button presses so it's mode needs to be set to input.

In the main program loop we check the state of digital pin 2 with this statement:-

```
int state = digitalRead(button);
```

This initialises an integer( yes it's wasteful and we should use a boolean) called 'state' and then sets the value of state to be the value of the digital pin 2. The `digitalRead` statement reads the state of the digital pin within the parenthesis and returns it to the integer we have assigned it to. We can then check the value in state to see if the button has been pressed or not.

```
if (state == HIGH && (millis() - changeTime) > 5000) {
    // Call the function to change the lights
    changeLights();
}
```

The `if` statement is an example of a control structure and it's purpose is to check if a certain condition has been met or not and if so to execute the code within it's code block. For example, if we wanted to turn an LED on if a variable called x rose above the value of 500 we could write

```
if (x>500) {digitalWrite(ledPin, HIGH);
```

When we read a digital pin using the `digitalRead` command, the state of the pin will either be `HIGH` or `LOW`. So the `if` command in our sketch looks like this

```
if (state == HIGH && (millis() - changeTime) > 5000)
```

What we are doing here is checking that two conditions have been met. The first is that the variable called state is high. If the button has been pressed state will be high as we have already set it to be the value read in from digital pin 2. We are also checking that the value of `millis()-changeTime` is greater than 5000 (using the logical AND command `&&`). The `millis()` function is one built into the Arduino language and it returns the number of milliseconds since the Arduino started to run the current program. Our `changeTime` variable will initially hold no value, but after the `changeLights` function has ran we set it at the end of that function to the current `millis()` value.

By subtracting the value in the `changeTime` variable from the current `millis()` value we can check if 5 seconds have passed since `changeTime` was last set. The calculation of `millis()-changeTime` is put inside it's own set of parenthesis to ensure that we compare the value of state and the result of this calculation and not the value of `millis()` on its own.

The symbol '&&' in between

```
state == HIGH
```

and the calculation is an example of a Boolean Operator. In this case it means AND. To see what we mean by that, let's take a look at all of the Boolean Operators.

```
&&    Logical AND
||    Logical OR
!     NOT
```

These are logic statements and can be used to test various conditions in if statements.

`&&` means true if both operands are true, e.g. :

```
if (x==5 && y==10) {....
```

This `if` statement will run it's code only if x is 5 and also y is 10.

`||` means true if either operand is true, e.g. :

```
if (x==5 || y==10) {.....
```

This will run if x is 5 or if y is 10.

The `!` or NOT statement means true if the operand is false, e.g. :

```
if (!x) {.....
```

Will run if x is false, i.e. equals zero.

You can also 'nest' conditions with parenthesis, for example

```
if (x==5 && (y==10 || z==25)) {.....
```

In this case, the conditions within the parenthesis are processed separately and treated as a single condition and then compared with the second condition. So, if we draw a simple truth table for this statement we can see how it works.

x	y	z	True/False?
4	9	25	FALSE
5	10	24	TRUE
7	10	25	FALSE
5	10	25	TRUE

The command within the `if` statement is

```
changeLights();
```

and this is an example of a function call. A function is simply a separate code block that has been given a name. However, functions can be passed parameters and/or return data too. In this case we have not passed any data to the function nor have we had the function return any data. We will go into more detail later on about passing parameters and returning data from functions.

When `changeLights()` is called, the code execution jumps from the current line to the function, executes the code within that function and then returns to the point in the code after where the function was called.

So, in this case, if the conditions in the `if` statement are met, then the program executes the code within the function and then returns to the next line after `changeLights()` in the `if` statement.

The code within the function simply changes the vehicles lights to red, via amber, then turns on the green pedestrian light. After a period of time set by the variable `crossTime` the light flashes a few time to warn the pedestrian that his time is about to run out, then the pedestrian light goes red and the vehicle light goes from red to green, via amber and returns to it's normal state.

The main program loop simply checks continuously if the pedestrian button has been pressed or not and if it has, and (&&) the time since the lights were last changed is greater than 5 seconds, it calls the `changeLights()` function again.

In this program there was no benefit from putting the code into it's own function apart from making the code look cleaner. It is only when a function is passed parameters and/or returns data that their true benefits come to light and we will take a look at that later on.

Next, we are going to use a lot more LED's as we make a 'Knight Rider' style LED chase effect.

# Project 5

LED Chase Effect





# Project 5 - LED Chase Effect

We are now going to use a string of LED's (10 in total) to make an LED chase effect, similar to that used on the car KITT in the Knight Rider TV Series and on the way introduce the concept of arrays.

## Connect it up

### What you will need

10 x Red Diffused LED's	
10 x 220Ω Resistors	

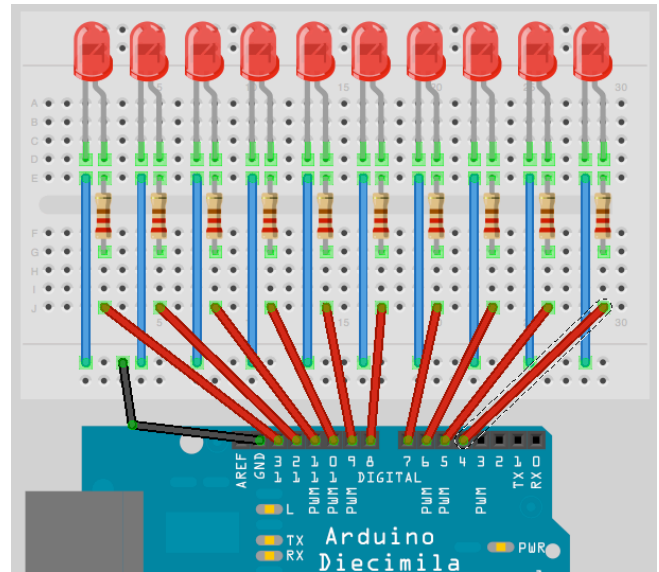

### Enter the code

```
// Project 5 - LED Chase Effect
// Create array for LED pins
byte ledPin[] = {4, 5, 6, 7, 8, 9, 10, 11, 12, 13};
int ledDelay(65); // delay between changes
int direction = 1;
int currentLED = 0;
unsigned long changeTime;

void setup() {
  // set all pins to output
  for (int x=0; x<10; x++) {
    pinMode(ledPin[x], OUTPUT);
    changeTime = millis();
  }
}

void loop() {
  // if it has been ledDelay ms since last change
  if ((millis() - changeTime) > ledDelay) {
    changeLED();
    changeTime = millis();
  }
}

void changeLED() {
  // turn off all LED's
  for (int x=0; x<10; x++) {
    digitalWrite(ledPin[x], LOW);
  }
  // turn on the current LED
  digitalWrite(ledPin[currentLED], HIGH);
  // increment by the direction value
  currentLED += direction;
  // change direction if we reach the end
  if (currentLED == 9) {direction = -1;}
  if (currentLED == 0) {direction = 1;}
}
```

# Project 5 – Code Overview

Our very first line in this sketch is

```
byte ledPin[] = {4, 5, 6, 7, 8, 9, 10, 11, 12, 13};
```

and this is a declaration of a variable of data type array. An array is a collection of variables that are accessed using an index number. In our sketch we have declared an array of data type byte and called it ledPin. We have then initialised the array with 10 values, which are the digital pins 4 through to 13. To access an element of the array we simply refer to the index number of that element. Arrays are zero indexed, which simply means that the first index starts at zero and not 1. So in our 10 element array the index numbers are 0 to 9.

In this case, element 3 (ledPin[2]) has the value of 6 and element 7 (ledPin[6]) has a value of 10.

You have to tell the size of the array if you do not initialise it with data first. In our sketch we did not explicitly choose a size as the compiler is able to count the values we have assigned to the array to work out that the size is 10 elements. If we had declared the array but not initialised it with values at the same time, we would need to declare a size, for example we could have done this:

```
byte ledPin[10];
```

and then loaded data into the elements later on. To retrieve a value from the array we would do something like this:

```
x = ledpin[5];
```

In this example x would now hold a value of 8. To get back to your program, we have started off by declaring and initialising an array and have stored 10 values that are the digital pins used for the outputs to our 10 LED's.

In our main loop we check that at least ledDelay milliseconds have passed since the last change of LED's and if so it passes control to our function. The reason we are only going to pass control to the changeLED() function in this way, rather than using delay() commands, is to allow other code if needed to run in the main program loop (as long as that code takes less than ledDelay to run).

The function we created is

```
void changeLED() {
  // turn off all LED's
  for (int x=0; x<10; x++) {
    digitalWrite(ledPin[x], LOW);
  }
  // turn on the current LED
  digitalWrite(ledPin[currentLED], HIGH);
  // increment by the direction value
  currentLED += direction;
  // change direction if we reach the end
  if (currentLED == 9) {direction = -1;}
  if (currentLED == 0) {direction = 1;}
}
```

and the job of this function is to turn all LED's off and then turn on the current LED (this is done so fast you will not see it happening), which is stored in the variable currentLED.

This variable then has direction added to it. As direction can only be either a 1 or a -1 then the number will either increase (+1) or decrease by one (currentLED +(-1)).

We then have an if statement to see if we have reached the end of the row of LED's and if so we then reverse the direction variable.

By changing the value of ledDelay you can make the LED ping back and forth at different speeds. Try different values to see what happens.

However, you have to stop the program and manually change the value of ledDelay then upload the amended code to see any changes. Wouldn't it be nice to be able to adjust the speed whilst the program is running? Yes it would, so let's do exactly that in the next project by introducing a way to interact with the program and adjust the speed using a potentiometer.

# Project 6

Interactive LED Chase Effect

# Project 6 - Interactive LED Chase Effect

We are now going to use a string of LED's (10 in total) to make an LED chase effect, similar to that used on the car KITT in the Knightrider TV Series and on the way introduce the concept of arrays.

## What you will need

Parts from previous project plus....	
4K7 Potentiometer	

## Connect it up

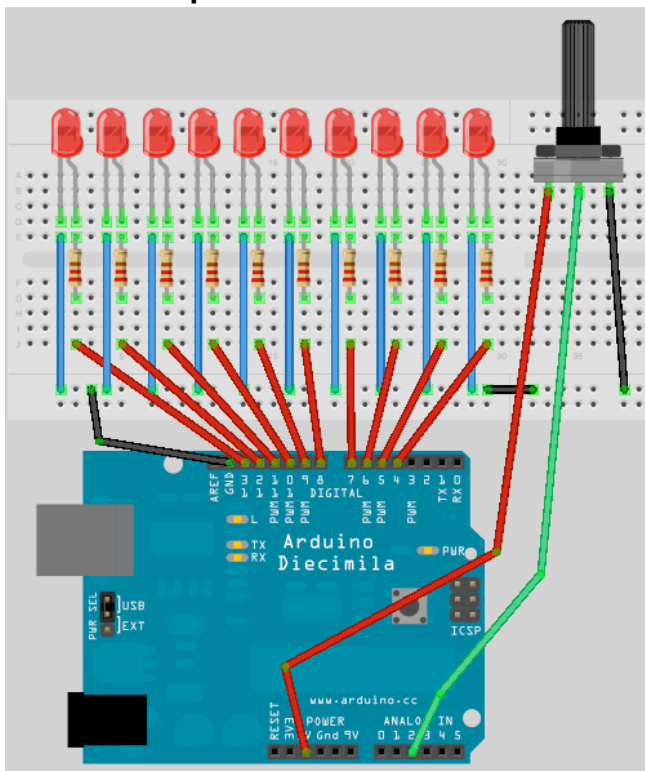

This is the same circuit as in Project 5, but we have simply added the potentiometer and connected it to 5v, Ground and Analog Pin 5.

## Enter the code

```
// Create array for LED pins
byte ledPin[] = {4, 5, 6, 7, 8, 9, 10, 11, 12, 13};
int ledDelay; // delay between changes
int direction = 1;
int currentLED = 0;
unsigned long changeTime;
int potPin = 2; // select the input pin for the potentiometer

void setup() {
  // set all pins to output
  for (int x=0; x<10; x++) {
    pinMode(ledPin[x], OUTPUT); }
  changeTime = millis();
}

void loop() {
  // read the value from the pot
  ledDelay = analogRead(potPin);
  // if it has been ledDelay ms since last change
  if ((millis() - changeTime) > ledDelay) {
    changeLED();
    changeTime = millis();
  }
}

void changeLED() {
  // turn off all LED's
  for (int x=0; x<10; x++) {
    digitalWrite(ledPin[x], LOW);
  }
  // turn on the current LED
  digitalWrite(ledPin[currentLED], HIGH);
  // increment by the direction value
  currentLED += direction;
  // change direction if we reach the end
  if (currentLED == 9) {direction = -1;}
  if (currentLED == 0) {direction = 1;}
}
```

This time when verify and upload your code, you should now see the lit LED appear to bounce back and forth between each end of the string of lights as before. But, by turning the knob of the potentiometer, you will change the value of ledDelay and speed up or slow down the effect.

Let's take a look at how this works and find our what a potentiometer is.

# Project 6 – Code Overview

```
// Create array for LED pins
byte ledPin[] = {4, 5, 6, 7, 8, 9, 10, 11,
12, 13};
int ledDelay; // delay between changes
int direction = 1;
int currentLED = 0;
unsigned long changeTime;
int potPin = 2; // select the input pin
for the potentiometer

void setup() {
  // set all pins to output
  for (int x=0; x<10; x++) {
    pinMode(ledPin[x], OUTPUT); }
  changeTime = millis();
}

void loop() {
  // read the value from the pot
  ledDelay = analogRead(potPin);
  // if it has been ledDelay ms since last
  change
  if ((millis() - changeTime) > ledDelay) {
    changeLED();
    changeTime = millis();
  }
}

void changeLED() {
  // turn off all LED's
  for (int x=0; x<10; x++) {
    digitalWrite(ledPin[x], LOW);
  }
  // turn on the current LED
  digitalWrite(ledPin[currentLED], HIGH);
  // increment by the direction value
  currentLED += direction;
  // change direction if we reach the end
  if (currentLED == 9) {direction = -1;}
  if (currentLED == 0) {direction = 1;}
}
}
```

The code for this Project is almost identical to the previous project. We have simply added a potentiometer to our hardware and the code has additions to enable us to read the values from the potentiometer and use them to adjust the speed of the LED chase effect.

We first declare a variable for the potentiometer pin

```
int potPin = 2;
```

as our potentiometer is connected to analog pin 2. To read the value from an analog pin we use the `analogRead` command. The Arduino has 6 analog input/outputs with a 10-bit analog to digital convertor (we will discuss bits later on). This means the analog pin can read in voltages between 0 to 5 volts in integer values between 0 (0 volts) and 1023 (5 volts). This gives a resolution of 5 volts / 1024 units or 0.0049 volts (4.9mV) per unit.

We need set our delay using the potentiometer so we will simply use the direct values read in from the pin to adjust the delay between 0 and 1023 milliseconds. We do this by directly reading the value of the potentiometer pin into `ledDelay`. Notice that we do not need to set an analog pin to be an input or output like we need to with a digital pin.

```
ledDelay = analogRead(potPin);
```

This is done during our main loop and therefore it is constantly being read and adjusted. By turning the knob you can adjust the delay value between 0 and 1023 milliseconds (or just over a second) and therefore have full control over the speed of the effect.

OK let's find out what a potentiometer is and how it works.

# Project 6 – Hardware Overview

The only additional piece of hardware used in this project was the 4K7 (4700Ω) potentiometer.

You have already come across a resistor and know how they work. The potentiometer is simply an adjustable resistor with a range from 0 to a set value (written on the side of the pot). In the kit you have been given a 4K7 or 4,700Ω potentiometer which means it's range is from 0 to 4700 Ohms.



resistor. By connecting all 3 legs and applying a voltage across it, the pot becomes a voltage divider. This is how we have used it in our circuit. One side is connected to ground, the other to 5v and the centre pin to our analog pin. By adjusting the knob, a voltage between 0 and 5v will be leaked from the centre pin and we can read the value of that voltage on Analog Pin 2 and use it's value to change the delay rate of the light effect.

The potentiometer can be very useful in providing a means of adjusting a value from 0 to a set amount, e.g. the volume of a radio or the brightness of a lamp. In fact, dimmer switches for your home lamps are a kind of potentiometer.

The potentiometer has 3 legs. By connecting up just two legs the potentiometer becomes a variable

## Exercises

1. Get the LED's at BOTH ends of the strip to start as on, then to both move towards each other, appear to bounce off each other and then move back to the end.
2. Make a bouncing ball effect by making the LED start at one end, 'drop' toward the other end, bounce back up, but to only go up 9 spaces, bounce, go up 8 spaces, then 7, then 6, etc. To give the effect it is a bouncing ball, getting bouncing up to a lower height on each bounce.

# Project 7



## Pulsating Lamp

# Project 7 - Pulsating Lamp

We are now going to delve further into a more advanced method of controlling LED's. So far we have simply turned the LED on or off. How about being able to adjust it's brightness too? Can we do that with an Arduino? Yes we can.

Time to go back to basics.

## What you will need

Green Diffused LED	
220Ω Resistor	

## Connect it up

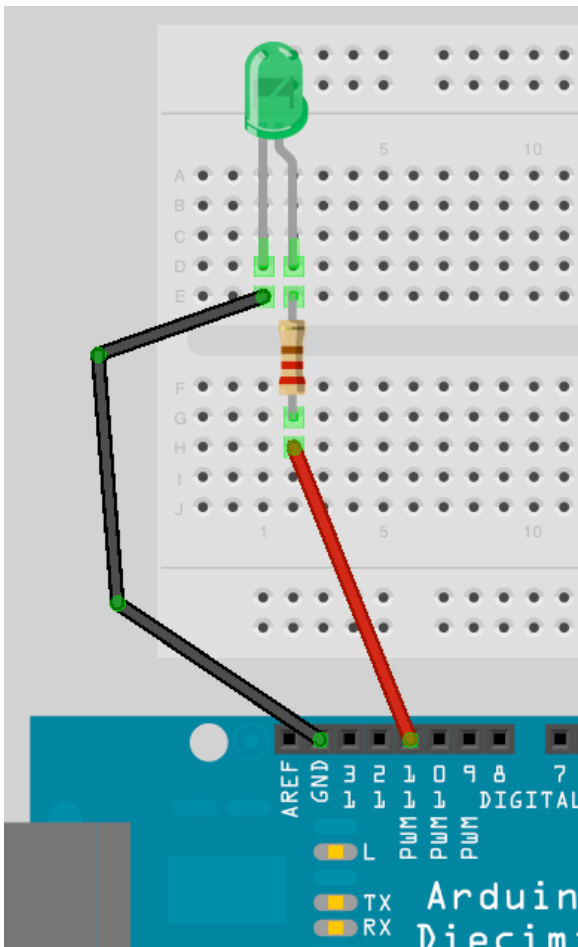

## Enter the code

Enter this simple program.

```
// Project 7 - Pulsating lamp

int ledPin = 11;
float sinVal;
int ledVal;

void setup() {
  pinMode(ledPin, OUTPUT);
}

void loop() {
  for (int x=0; x<180; x++) {
    // convert degrees to radians
    // then obtain sin value
    sinVal = (sin(x*(3.1412/180)));
    ledVal = int(sinVal*255);
    analogWrite(ledPin, ledVal);
    delay(25);
  }
}
```

Verify and upload. You will now see your LED pulsate on and off steadily. Instead of a simple on/off state we are now adjusting it's brightness. Let's find out how this works.



# Project 7 – Code Overview

The code for this project is very simple, but requires some explanation.

```
// Project 7 - Pulsating lamp

int ledPin = 11;
float sinVal;
int ledVal;

void setup() {
  pinMode(ledPin, OUTPUT);
}

void loop() {
  for (int x=0; x<180; x++) {
    // convert degrees to radians
    // then obtain sin value
    sinVal = (sin(x*(3.1412/180)));
    ledVal = int(sinVal*255);
    analogWrite(ledPin, ledVal);
    delay(25);
  }
}
```

We first set up the variables for the LED Pin, a float (floating point data type) for a sine wave value and ledVal which will hold the integer value to send out to Pin 11.

The concept here is that we are creating a sine wave and having the brightness of the LED follow the path of that wave. This is what makes the light pulsate in that way instead of just fade up to full brightness and back down again.

We use the sin() function, which is a mathematical function to work out the sine of an angle. We need to give the function the degree in radians. We have a for loop that goes from 0 to 179, we don't want to go past halfway as this will take us into negative values and the brightness value we need to put out to Pin 11 needs to be from 0 to 255 only.

The sin() function requires the angle to be in radians and not degrees so the equation of  $x*(3.1412/180)$  will convert the degree angle into radians. We then transfer the result to ledVal, multiplying it by 255 to give us our value. The result from the sin() function will be a number between -1 and 1 so we need to multiply that by 255 to give us our maximum brightness. We 'cast' the floating point value of sinVal into an integer by the use of int() in the statement

```
ledVal = int(sinVal*255);
```

Then we send that value out to Digital Pin 11 using the statement

```
analogWrite(ledPin, ledVal);
```

But, how can we send an analog value to a digital pin? Well, if we take a look at our Arduino and look at the Digital Pins you can see that 6 of those pins (3, 5, 6, 9, 10 & 11) have PWM written next to them. Those pins differ from the remaining digital pins in that they are able to send out a PWM signal.

PWM stands for Pulse Width Modulation. PWM is a technique for getting analog results from digital means. On these pins the Arduino sends out a square wave by switching the pin on and off very fast. The pattern of on/off's can simulate a varying voltage between 0 and 5v. It does this by changing the amount of time that the output remains high (on) versus off (low). The duration of the on time is known as the 'Pulse Width'.

For example, if you were to send the value 0 out to Pin 11 using analogWrite() the ON period would be zero, or it would have a 0% Duty Cycle. If you were to send a value of 64 (25% of the maximum of 255) the pin would be ON for 25% of the time and OFF for 75% of the time. The value of 191 would have a Duty Cycle of 75% and a value of 255 would have a duty cycle of 100%. The pulses run at a speed of approx. 500Hz or 2 milliseconds each.

So, from this we can see in our sketch that the LED is being turned on and off very fast. If the Duty Cycle was 50% (a value of 127) then the LED would pulse on and off at 500Hz and would display at half the maximum brightness. It is basically an illusion that we can use to our advantage by allowing us to use the digital pins to output a simulated analog value to our LED's.

Note that even though only 6 of the pins have the PWM function, you can easily write software to give a PWM output from all of the digital pins if you wish.

Later on we will revisit PWM as we can utilise it to create audible tones using a piezo sounder.



# Project 8

## Mood Lamp

# Project 8 - Mood Lamp

In the last project we saw that we could adjust the brightness of an LED using the PWM capabilities of the Atmega chip. We will now take advantage of this capability by using a red, green and blue LED and by mixing their colours to create any colour we wish. From that, we will create a mood lamp similar to the kind you see for sale all over the place nowadays.

## What you will need

Red Clear LED	
Green Clear LED	
Blue Clear LED	
3 x 220Ω Resistor	

## Connect it up

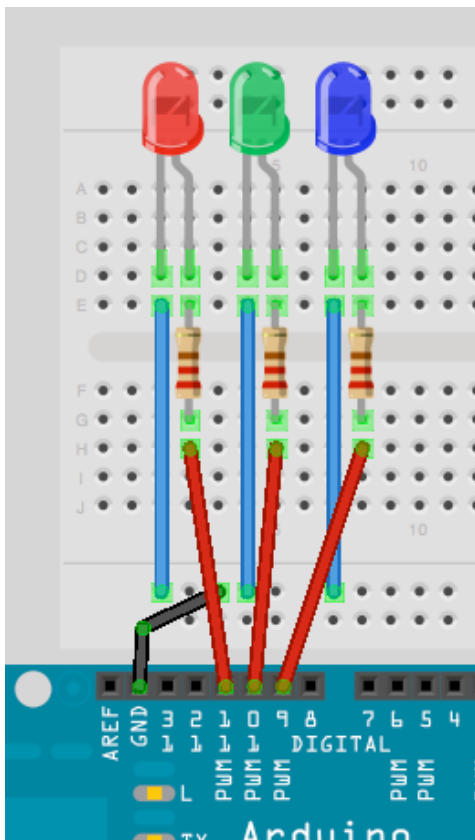

Get a piece of paper about A5 size, roll it into a cylinder then tape it so it remains that way. Then place the cylinder over the top of the 3 LED's.

## Enter the code

```
// Project 8 - Mood Lamp
float RGB1[3];
float RGB2[3];
float INC[3];

int red, green, blue;

int RedPin = 11;
int GreenPin = 10;
int BluePin = 9;

void setup()
{
  Serial.begin(9600);
  randomSeed(analogRead(0));

  RGB1[0] = 0;
  RGB1[1] = 0;
  RGB1[2] = 0;

  RGB2[0] = random(256);
  RGB2[1] = random(256);
  RGB2[2] = random(256);
}

void loop()
{
  randomSeed(analogRead(0));

  for (int x=0; x<3; x++) {
    INC[x] = (RGB1[x] - RGB2[x]) / 256; }

  for (int x=0; x<256; x++) {

    red = int(RGB1[0]);
    green = int(RGB1[1]);
    blue = int(RGB1[2]);

    analogWrite (RedPin, red);
    analogWrite (GreenPin, green);
    analogWrite (BluePin, blue);
    delay(100);

    RGB1[0] -= INC[0];
    RGB1[1] -= INC[1];
    RGB1[2] -= INC[2];
  }
  for (int x=0; x<3; x++) {
    RGB2[x] = random(556)-300;
    RGB2[x] = constrain(RGB2[x], 0, 255);
    delay(1000);
  }
}
```

When you run this you will see the colours slowly change. You've just made your own mood lamp.

# Project 8 – Code Overview

The LED's that make up the mood lamp are red, green and blue. In the same way that your computer monitor is made up of tiny red, green and blue (RGB) dots, the map can generate different colours by adjusting the brightness of each of the 3 LED's in such a way to give us a different RGB value.

An RGB value of 255, 0, 0 would give us pure red. A value of 0, 255, 0 would give pure green and 0, 0, 255 pure blue. By mixing these we can get any colour we like with This is the additive colour model. If you were just turn the LED's ON or OFF (i.e. Not have different brightnesses) you would still get different colours as in this table.

Red	Green	Blue	Colour
255	0	0	Red
0	255	0	Green
0	0	255	Blue
255	255	0	Yellow
0	255	255	Cyan
255	0	255	Magenta
255	255	255	White

By adjusting the brightnesses using PWM we can get every other colour in between too. By placing the LED's close together and by mixing their values, the light spectra of the 3 colours added together make a single colour. By diffusing the light with our paper cylinder we ensure the colours are mixed nicely. The LED's can be placed into any object that will diffuse the light or you can bounce the light off a reflective diffuser. Try putting the lights inside a ping pong ball or a small white plastic bottle (the thinner the plastic the better).

The total range of colours we can get using PWM with a range of 0 to 255 is 16,777, 216 colours (256x256x256) which is way more than we would ever need.

In the code, we start off by declaring some floating point arrays and also some integer variables that will store our RGB values as well as an increment value.

```
float RGB1[3];
float RGB2[3];
float INC[3];

int red, green, blue;
```

In the setup function we have

```
randomSeed(analogRead(0));
```

The randomSeed command is used for creating random (actually pseudo-random) numbers. Computer chips are not able to produce truly random numbers so they tend to look at data in a part of it's memory that may differ or look at a table of different values and use those as a pseudo-random number. By setting a 'seed', you can tell the computer where in memory or in that table to start counting from. In this case the value we give to the randomSeed is a value read from Analog Pin 0. As we don't have anything connected to Analog Pin 0 all we will read is a random number created by analog noise.

Once we have set a 'seed' for our random number we can create one using the random() function. We then have two sets of RGB values stored in a 3 element array. RGB1 is the RGB values we want the lamp to start with (in this case all zeros or off).

```
RGB1[0] = 0;
RGB1[1] = 0;
RGB1[2] = 0;
```

Then the RGB2 array is a set of random RGB values that we want the lamp to transition to,

```
RGB2[0] = random(256);
RGB2[1] = random(256);
RGB2[2] = random(256);
```

In this case we have set them to a random number set by random(256) which will give is a number between 0 and 255 inclusive (as the number will always range from zero upwards).

If you pass a single number to the random() function then it will return a value between 0 and 1 less than the number, e.g. random(1000) will return a number between 0 and 999. If you supply two numbers as it's parameters then it will return a random number between the lower number inclusive and the maximum number (-1). E.g. random(10,100) will return a random number between 10 and 99.

In the main program loop we first take a look at the start and end RGB values and work out what value is needed as an increment to progress from one value to the other in 256 steps (as the PWM value can only be between 0 and 255). We do this with

```
for (int x=0; x<3; x++) {
  INC[x] = (RGB1[x] - RGB2[x]) / 256; }
```

This for loop sets the INCRement values for the R, G and B channels by working out the difference between the two brightness values and dividing that by 256.

We then have another for loop

```
for (int x=0; x<256; x++) {
    red = int(RGB1[0]);
    green = int(RGB1[1]);
    blue = int(RGB1[2]);

    analogWrite (RedPin, red);
    analogWrite (GreenPin, green);
    analogWrite (BluePin, blue);
    delay(100);

    RGB1[0] -= INC[0];
    RGB1[1] -= INC[1];
    RGB1[2] -= INC[2];
}
```

and this sets the red, green and blue values to the values in the RGB1 array, writes those values to pins 9, 10 and 11, then deducts the increment value then repeats this process 256 times to slowly fade from one random colour to the next. The delay of 100ms in between each step ensures a slow and steady progression. You can of course adjust this value if you want it slower or faster or you can add a potentiometer to allow the user to set the speed.

After we have taken 256 slow steps from one random colour to the next, the RGB1 array will have the same values (nearly) as the RGB2 array. We now need to decide upon another set of 3 random values ready for the next time. We do this with another for loop

```
for (int x=0; x<3; x++) {
    RGB2[x] = random(556)-300;
    RGB2[x] = constrain(RGB2[x], 0, 255);
    delay(1000);
}
```

The random number is chosen by picking a random number between 0 and 556 (256+300) and then deducting 300. The reason we do that is to try and force primary colours from time to time to ensure we don't always just get pastel shades. We have 300 chances out of 556 in getting a negative number and therefore forcing a bias towards one or more of the other two colour channels. The next command makes sure that the numbers sent to the PWM pins are not negative by using the constrain() function.

The constrain function requires 3 parameters - x, a and b as in constrain(x, a, b) where x is the number we want to constrain, a is the lower end of the range and b is the higher end. So, the constrain function looks at the value of x and makes sure it is within the range of a to b. If it is lower than a then it sets it to a, if it is higher than b it sets it to b. In our case we make sure that the number is between 0 and 255 which is the range of our PWM output.

As we use random(556)-300 for our RGB values, some of those values will be lower than zero and the constrain function makes sure that the value sent to the PWM is not lower than zero.

Forcing a bias towards one or more of the other two channels ensures more vibrant and less pastel shades of colour and also ensures that from time to time one or more channels are turned off completely giving a more interesting change of lights (or moods).

### Exercise

See if you can make the lights cycle through the colours of the rainbow rather than between random colours.



# Project 9

## LED Fire Effect

# Project 9 - LED Fire Effect

Project 9 will use LED's and a flickering random light effect, using PWM again, to recreate the effect of a flickering flame. If you were to place these LED's inside a model house on a model railway layout, for example, you could create a special effect of the house being on fire, or you could place it into a fake fireplace in your house to give a fire effect. This is a simple example of how LED's can be used to create SFX for movies, stage plays, model diorama's, model railways, etc.

## What you will need

Red Diffused LED	
2 x Yellow Diffused LED's	
3 x 150Ω Resistor	

## Connect it up

Now, first make sure that your Arduino is powered off. You can do this either by unplugging the USB cable or by taking out the Power Selector Jumper on the Arduino board. Then connect everything up like this :-

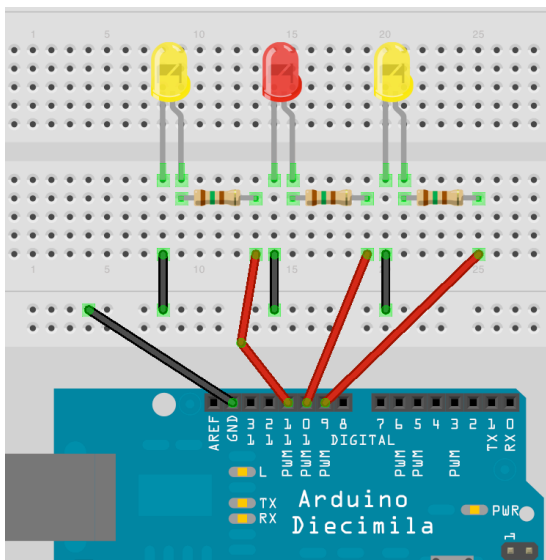

When you are happy that everything is connected up correctly, power up your Arduino and connect the USB cable.

## Enter the code

Now, open up the Arduino IDE and type in the following code :-

```
// Project 9 - LED Fire Effect

int ledPin1 = 9;
int ledPin2 = 10;
int ledPin3 = 11;

void setup()
{
  pinMode(ledPin1, OUTPUT);
  pinMode(ledPin2, OUTPUT);
  pinMode(ledPin3, OUTPUT);
}

void loop()
{
  analogWrite(ledPin1, random(120)+135);
  analogWrite(ledPin2, random(120)+135);
  analogWrite(ledPin3, random(120)+135);
  delay(random(100));
}
```

Now press the Verify/Compile button at the top of the IDE to make sure there are no errors in your code. If this is successful you can now click the Upload button to upload the code to your Arduino.

If you have done everything right you should now see the LED's flickering in a random manner to simulate a flame or fire effect.

Now let's take a look at the code and the hardware and find out how they both work.

# Project 9 - Code Overview

```
// Project 9 - LED Fire Effect
```

```
int ledPin1 = 9;
int ledPin2 = 10;
int ledPin3 = 11;

void setup()
{
  pinMode(ledPin1, OUTPUT);
  pinMode(ledPin2, OUTPUT);
  pinMode(ledPin3, OUTPUT);
}

void loop()
{
  analogWrite(ledPin1, random(120)+135);
  analogWrite(ledPin2, random(120)+135);
  analogWrite(ledPin3, random(120)+135);
  delay(random(100));
}
```

So let's take a look at the code for this project. First we declare and initialise some integer variables that will hold the values for the Digital Pins we are going to connect our LED's to.

```
int ledPin1 = 9;
int ledPin2 = 10;
int ledPin3 = 11;
```

We then set them up to be outputs.

```
pinMode(ledPin1, OUTPUT);
pinMode(ledPin2, OUTPUT);
pinMode(ledPin3, OUTPUT);
```

The main program loop then sends out a random value between 0 and 120, and then add 135 to it to get full LED brightness, to the PWM pins 9, 10 and 11.

```
analogWrite(ledPin1, random(120)+135);
analogWrite(ledPin2, random(120)+135);
analogWrite(ledPin3, random(120)+135);
```

Then finally we have a random delay between on and 100ms.

```
delay(random(100));
```

The main loop then starts again causing the flicker light effect you can see.

Bounce the light off a white card or a mirror onto your wall and you will see a very realistic flame effect.

As the hardware is simple and we should understand it by now we will jump right into Project 10.

## Exercises

1. Using a blue LED or two, see if you can recreate the effect of the flashes of light from an arc welder.
2. Using a Blue and Red LED recreate the effect of the lights on an emergency vehicle.



# Project 10

Serial Controlled Mood Lamp

# Project 10 - Serial Controlled Mood Lamp

We will now use the same circuit as in Project 9, but will now delve into the world of serial communications and control our lamp by sending commands from the PC to the Arduino using the Serial Monitor in the Arduino IDE. This project also introduces how we manipulate text strings. So leave the hardware set up the same as before and enter the new code.

## Enter the code

```
// Project 10 - Serial controlled RGB Lamp

char buffer[18];
int red, green, blue;

int RedPin = 11;
int GreenPin = 10;
int BluePin = 9;

void setup()
{
  Serial.begin(9600);
  Serial.flush();
  pinMode(RedPin, OUTPUT);
  pinMode(GreenPin, OUTPUT);
  pinMode(BluePin, OUTPUT);
}

void loop()
{
  if (Serial.available() > 0) {
    int index=0;
    delay(100); // let the buffer fill up
    int numChar = Serial.available();
    if (numChar>15) {
      numChar=15;
    }
    while (numChar-->0) {
      buffer[index++] = Serial.read();
    }
    splitString(buffer);
  }
}

void splitString(char* data) {
  Serial.print("Data entered: ");
  Serial.println(data);
  char* parameter;
  parameter = strtok (data, " ,");
  while (parameter != NULL) {
    setLED(parameter);
    parameter = strtok (NULL, " ,");
  }

  // Clear the text and serial buffers
  for (int x=0; x<16; x++) {
    buffer[x]='\0';
  }
  Serial.flush();
}
```

*(continued on next page.....)*

```

void setLED(char* data) {
  if ((data[0] == 'r') || (data[0] == 'R')) {
    int Ans = strtol(data+1, NULL, 10);
    Ans = constrain(Ans,0,255);
    analogWrite(RedPin, Ans);
    Serial.print("Red is set to: ");
    Serial.println(Ans);
  }
  if ((data[0] == 'g') || (data[0] == 'G')) {
    int Ans = strtol(data+1, NULL, 10);
    Ans = constrain(Ans,0,255);
    analogWrite(GreenPin, Ans);
    Serial.print("Green is set to: ");
    Serial.println(Ans);
  }
  if ((data[0] == 'b') || (data[0] == 'B')) {
    int Ans = strtol(data+1, NULL, 10);
    Ans = constrain(Ans,0,255);
    analogWrite(BluePin, Ans);
    Serial.print("Blue is set to: ");
    Serial.println(Ans);
  }
}
}

```

(continued from previous page.....)

Once you've verified the code, upload it to your Arduino.

Now when you upload the program nothing seems to happen. This is because the program is waiting for your input. Start the Serial Monitor by clicking its icon in the Arduino IDE taskbar.

In the Serial Monitor text window you can now enter the R, G and B values for each of the 3 LED's manually and the LED's will change to the colour you have input.

E.g. If you enter R255 the Red LED will display at full brightness.

If you enter R255, G255, then both the red and green LED's will display at full brightness.

Now enter R127, G100, B255 and you will get a nice purplish colour.

If you type, r0, g0, b0 all the LED's will turn off.

The input text is designed to accept both a lower-case or upper-case R, G and B and then a value from 0 to 255. Any values over 255 will be dropped down to 255 maximum. You can enter a comma or a space in between parameters and you can enter 1, 2 or 3 LED values at any one time.

E.g.

r255 b100

r127 b127 g127

G255, B0

B127, R0, G255

Etc.

# Project 10 - Code Overview

This project introduces a whole bunch of new concepts, including serial communication, pointers and string manipulation. So, hold on to your hats this will take a lot of explaining.

First we set up an array of char (characters) to hold our text string. We have made it 18 characters long, which is longer than the maximum of 16 we will allow to ensure we don't get "buffer overflow" errors.

```
char buffer[18];
```

We then set up the integers to hold the red, green and blue values as well as the values for the digital pins.

```
int red, green, blue;

int RedPin = 11;
int GreenPin = 10;
int BluePin = 9;
```

In our setup function we set the 3 digital pins to be outputs. But, before that we have the Serial.begin command.

```
void setup()
{
  Serial.begin(9600);
  Serial.flush();
  pinMode(RedPin, OUTPUT);
  pinMode(GreenPin, OUTPUT);
  pinMode(BluePin, OUTPUT);
}
```

Serial.begin tells the Arduino to start serial communications and the number within the parenthesis, in this case 9600, sets the baud rate (characters per second) that the serial line will communicate at.

The Serial.flush command will flush out any characters that happen to be in the serial line so that it is empty and ready for input/output.

The serial communications line is simply a way for the Arduino to communicate with the outside world, in this case to and from the PC and the Arduino IDE's Serial Monitor.

In the main loop we have an if statement. The condition it is checking for is

```
if (Serial.available() > 0) {
```

The Serial.available command checks to see if any characters have been sent down the serial line. If any characters have been received then the condition is

met and the code within the if statements code block is now executed.

```
if (Serial.available() > 0) {
  int index=0;
  delay(100); // let the buffer fill up
  int numChar = Serial.available();
  if (numChar>15) {
    numChar=15;
  }
  while (numChar-->0) {
    buffer[index++] = Serial.read();
  }
  splitString(buffer);
}
```

An integer called index is declared and initialised as zero. This integer will hold the position of a pointer to the characters within the char array.

We then set a delay of 100. The purpose of this is to ensure that the serial buffer (the place in memory where the serial data that is received is stored prior to processing) is full before we carry on and process the data. If we don't do that, it is possible that the function will execute and start to process the text string, before we have received all of the data. The serial communications line is very slow compared to the speed the rest of the code is executing at. When you send a string of characters the Serial.available function will immediately have a value higher than zero and the if function will start to execute. If we didn't have the delay(100) statement in there it could start to execute the code within the if statement before all of the text string had been received and the serial data may only be the first few characters of the line of text entered.

After we have waited for 100ms for the serial buffer to fill up with the data sent, we then declare and initialise the numChar integer to be the number of characters within the text string.

E.g. If we sent this text in the Serial Monitor:

```
R255, G255, B255
```

Then the value of numChar would be 17. It is 17 and not 16 as at the end of each line of text there is an invisible character called a NULL character. This is a 'nothing' symbol and simply tells the Arduino that the end of the line of text has been reached.

The next if statement checks if the value of numChar is greater than 15 or not and if so it sets it to be 15. This ensures that we don't overflow the array char buffer[18];

After this comes a while command. This is something we haven't come across before so let me explain.

We have already used the for loop, which will loop a set number of times. The while statement is also a loop, but one that executes only while a condition is true.

The syntax is

```
while(expression) {
    // statement(s)
}
```

In our code the while loop is

```
while (numChar--) {
    buffer[index++] = Serial.read();
}
```

The condition it is checking is simply numChar, so in other words it is checking that the value stored in the integer numChar is not zero. numChar has -- after it. This is what is known as a post-decrement. In other words, the value is decremented AFTER it is used. If we had used --numChar the value in numChar would be decremented (have one subtracted from it) before it was evaluated. In our case, the while loop checks the value of numChar and then subtracts one from it. If the value of numChar was not zero before the decrement, it then carries out the code within its code block.

numChar is set to the length of the text string that we have entered into the Serial Monitor window. So, the code within the while loop will execute that many times.

The code within the while loop is

```
buffer[index++] = Serial.read();
```

Which sets each element of the buffer array to each character read in from the Serial line. In other words, it fills up the buffer array with the letters we have entered into the Serial Monitor's text window.

The Serial.read() command reads incoming serial data, one byte at a time.

So now that our character array has been filled with the characters we entered in the Serial Monitor the while loop will end once numChar reaches zero (i.e. The length of the string).

After the while loop we have

```
splitString(buffer);
```

Which is a call to one of the two functions we have created and called splitString(). The function looks like this:

```
void splitString(char* data) {
    Serial.print("Data entered: ");
    Serial.println(data);
    char* parameter;
    parameter = strtok (data, " ,");
    while (parameter != NULL) {
        setLED(parameter);
        parameter = strtok (NULL, " ,");
    }

    // Clear the text and serial buffers
    for (int x=0; x<16; x++) {
        buffer[x]='\0';
    }
    Serial.flush();
}
```

We can see that the function returns no data, hence it's data type has been set to void. We pass the function one parameter and that is a char data type that we have called data. However, in the C and C++ programming languages you are not allowed to send a character array to a function. We have got around that by using a pointer. We know we have used a pointer as an asterisk "\*" has been added to the variable name \*data. Pointers are quite an advanced subject in C so we won't go into too much detail about them. All you need to know for now is that by declaring 'data' as a pointer it is simply a variable that points to another variable.

You can either point it to the address that the variable is stored within memory by using the & symbol, or in our case, to the value stored at that memory address using the \* symbol. We have used it to 'cheat' the system, as we are not allowed to send a character array to a function. However we are allowed to send a pointer to a character array to our function. So, we have declared a variable of data type Char and called it data, but the \* symbol before it means that it is 'pointing to' the value stored within the 'buffer' variable.

When we called splitString we sent it the contents of 'buffer' (actually a pointer to it as we saw above).

```
splitString(buffer);
```

So we have called the function and passed it the entire contents of the buffer character array.

The first command is

```
Serial.print("Data entered: ");
```

and this is our way of sending data back from the Arduino to the PC. In this case the print command sends whatever is within the parenthesis to the PC, via the USB cable, where we can read it in the Serial Monitor window. In this case we have sent the words "Data entered: ". Text must be enclosed within quotes "". The next line is similar

```
Serial.println(data);
```

and again we have sent data back to the PC, this time we send the char variable called data. The Char type variable we have called 'data' is a copy of the contents of the 'buffer' character array that we passed to the function. So, if our text string entered was

```
R255 G127 B56
```

Then the

```
Serial.println(data);
```

Command will send that text string back to the PC and print it out in the Serial Monitor window (make sure you have enabled the Serial Monitor window first).

This time the print command has \n on the end to make it println. This simply means 'print' with a 'linefeed'.

When we print using the print command, the cursor (the point at where the next symbol will appear) remains at the end of whatever we have printed. When we use the println command a linefeed command is issued or in other words the text prints and then the cursor drops down to the next line.

```
Serial.print("Data entered: ");
Serial.println(data);
```

If we look at our two print commands, the first one prints out "Data entered: " and then the cursor remains at the end of that text. The next print command will print 'data', or in other words the contents of the array called 'buffer' and then issue a linefeed, or drop the cursor down to the next line. This means that if we issue another print or println statement after this whatever is printed in the Serial Monitor window will appear on the next line underneath the last.

We then create a new char data type called parameter

**Char\*** parameter;

and as we are going to use this variable to access elements of the 'data' array it must be the same type, hence the \* symbol. You cannot pass data from one data type type variable to another as the data must be converted first. This variable is another example of one that has 'local scope'. It can be 'seen' only by the code within this function. If you try to access the parameter variable outside of the splitString function you will get an error.

We then use a strtok command, which is a very useful command to enable us to manipulate text strings. Strtok gets it's name from String and Token as it's purpose is to split a string using tokens. In our case the token it is looking for is a space or a comma. It is used to split text strings into smaller strings.

We pass the 'data' array to the strtok command as the first argument and the tokens (enclosed within quotes) as the second argument. Hence

```
parameter = strtok (data, " ,");
```

And it splits the string at that point. So we are using it to set 'parameter' to be the part of the string up to a space or a comma.

So, if our text string was

```
R127 G56 B98
```

Then after this statement the value of 'parameter' will be

```
R127
```

as the strtok command would have split the string up to the first occurrence of a space or a comma.

After we have set the variable 'parameter' to the part of the text string we want to strip out (i.e. The bit up to the first space or comma) we then enter a while loop whose condition is that parameter is not empty (i.e. We haven't reached the end of the string) using

```
while (parameter != NULL) {
```

Within the loop we call our second function

```
setLED(parameter);
```

Which we will look at later on. Then it sets the variable 'parameter' to the next part of the string up to the next space or comma. We do this by passing to strtok a NULL parameter

```
parameter = strtok (NULL, " ,");
```

This tells the strtok command to carry on where it last left off.

So this whole part of the function

```
char* parameter;
parameter = strtok (data, " ,");
while (parameter != NULL) {
    setLED(parameter);
    parameter = strtok (NULL, " ,");
}
```

is simply stripping out each part of the text string that is separated by spaces or commas and sending that part of the string to the next function called setLED().

The final part of this function simply fills the buffer array with NULL character, which is done with the /0 symbol and then flushes the Serial data out of the Serial buffer ready for the next set of data to be entered.

```
// Clear the text and serial buffers
for (int x=0; x<16; x++) {
    buffer[x]='\0';
}
Serial.flush();
```

The setLED function is going to take each part of the text string and set the corresponding LED to the colour we have chosen. So, if the text string we enter is

G125 B55

Then the splitString() function splits that into the two separate components

G125  
B55

and send that shortened text string onto the setLED() function, which will read it, decide what LED we have chosen and set it to the corresponding brightness value.

So let's take a look at the second function called setLED().

```
void setLED(char* data) {
```

```
    if ((data[0] == 'r') || (data[0] == 'R'))
    {
        int Ans = strtol(data+1, NULL, 10);
        Ans = constrain(Ans,0,255);
        analogWrite(RedPin, Ans);
        Serial.print("Red is set to: ");
        Serial.println(Ans);
    }
    if ((data[0] == 'g') || (data[0] == 'G'))
    {
        int Ans = strtol(data+1, NULL, 10);
        Ans = constrain(Ans,0,255);
        analogWrite(GreenPin, Ans);
        Serial.print("Green is set to: ");
        Serial.println(Ans);
    }
    if ((data[0] == 'b') || (data[0] == 'B'))
    {
        int Ans = strtol(data+1, NULL, 10);
        Ans = constrain(Ans,0,255);
        analogWrite(BluePin, Ans);
        Serial.print("Blue is set to: ");
        Serial.println(Ans);
    }
}
```

We can see that this function contains 3 very similar if statements. We will therefore take a look at just one of them as the other 2 are almost identical.

```
if ((data[0] == 'r') || (data[0] == 'R')) {
    int Ans = strtol(data+1, NULL, 10);
    Ans = constrain(Ans,0,255);
    analogWrite(RedPin, Ans);
    Serial.print("Red is set to: ");
    Serial.println(Ans);
}
```

The if statement checks that the first character in the string data[0] is either the letter r or R (upper case and lower case characters are totally different as far as C is concerned. We use the logical OR command whose symbol is || to check if the letter is an r OR an R as either will do.

If it is an r or an R then the if statement knows we wish to change the brightness of the Red LED and so the code within executes. First we declare an integer called Ans (which has scope local to the setLED function only) and use the strtol (String to long integer) command to convert the characters after the letter R to an integer. The strtol command takes 3 parameters and these are the string we are passing it, a pointer to the character after the integer (which we don't use as we have already stripped the string using the strtok command and hence pass a NULL character) and then the 'base', which in our case is base 10 as we are using normal decimal numbers

(as opposed to binary, octal or hexadecimal which would be base 2, 8 and 16 respectively). So in other words we declare an integer and set it to the value of the text string after the letter R (or the number bit).

Next we use the constrain command to make sure that Ans goes from 0 to 255 and no more. We then carry out an analogWrite command to the red pin and send it the value of Ans. The code then sends out "Red is set to:" followed by the value of Ans back to the Serial Monitor. The other two if statements do

exactly the same but for the Green and the Blue LED's.

We have covered a lot of ground and a lot of new concepts in this project. To make sure you understand exactly what is going on in this code I am going to set the project code side by side with pseudo-code (an fake computer language that is essentially the computer language translated into a language humans can understand).

## The C Programming Language

```
// Project 10 - Serial controlled RGB Lamp

char buffer[18];
int red, green, blue;
int RedPin = 11;
int GreenPin = 10;
int BluePin = 9;

void setup()
{
  Serial.begin(9600);
  Serial.flush();
  pinMode(RedPin, OUTPUT);
  pinMode(GreenPin, OUTPUT);
  pinMode(BluePin, OUTPUT);
}

void loop()
{
  if (Serial.available() > 0) {
    int index=0;
    delay(100); // let the buffer fill up
    int numChar = Serial.available();
    if (numChar>15) {
      numChar=15;
    }
    while (numChar-->0) {
      buffer[index++] = Serial.read();
    }
    splitString(buffer);
  }
}

void splitString(char* data) {
  Serial.print("Data entered: ");
  Serial.println(data);
  char* parameter;
  parameter = strtok (data, " ,");
  while (parameter != NULL) {
    setLED(parameter);
    parameter = strtok (NULL, " ,");
  }
}

// Clear the text and serial buffers
for (int x=0; x<16; x++) {
  buffer[x]='\0';
}
Serial.flush();
}
```

Continued on next page.....

## Pseudo-Code

A comment with the project number and name

Declare a character array of 18 letters  
 Declare 3 integers called red, green and blue  
 An integer for which pin to use for Red LED  
 " " Green  
 " " Blue

The setup function

Set serial comms to run at 9600 chars per second  
 Flush the serial line  
 Set the red led pin to be an output pin  
 Same for green  
 And blue

The main program loop

If data is sent down the serial line...  
 Declare integer called index and set to 0  
 Wait 100 milliseconds  
 Set numChar to the incoming data from serial  
 If numchar is greater than 15 characters...  
 Make it 15 and no more

While numChar is not zero (subtract 1 from it)  
 Set element[index] to value read in (add 1)

Call splitString function and send it data in buffer

The splitstring function references buffer data  
 Print "Data entered: "  
 Print value of data and then drop down a line  
 Declare char data type parameter  
 Set it to text up to the first space or comma  
 While contents of parameter are not empty..  
 Call the setLED function  
 Set parameter to next part of text string

Another comment

We will do the next line 16 times  
 Set each element of buffer to NULL (empty)

Flush the serial comms



## The C Programming Language

*(continued from previous page.....)*

```
void setLED(char* data) {
    if ((data[0] == 'r') || (data[0] == 'R')) {
        int Ans = strtol(data+1, NULL, 10);
        Ans = constrain(Ans,0,255);
        analogWrite(RedPin, Ans);
        Serial.print("Red is set to: ");
        Serial.println(Ans);
    }
    if ((data[0] == 'g') || (data[0] == 'G')) {
        int Ans = strtol(data+1, NULL, 10);
        Ans = constrain(Ans,0,255);
        analogWrite(GreenPin, Ans);
        Serial.print("Green is set to: ");
        Serial.println(Ans);
    }
    if ((data[0] == 'b') || (data[0] == 'B')) {
        int Ans = strtol(data+1, NULL, 10);
        Ans = constrain(Ans,0,255);
        analogWrite(BluePin, Ans);
        Serial.print("Blue is set to: ");
        Serial.println(Ans);
    }
}
```

## Pseudo-Code

A function called setLED is passed buffer  
 If first letter is r or R...  
 Set integer Ans to number in next part of text  
 Make sure it is between 0 and 255  
 Write that value out to the red pin  
 Print out "Red is set to: "  
 And then the value of Ans

If first letter is g or G...  
 Set integer Ans to number in next part of text  
 Make sure it is between 0 and 255  
 Write that value out to the green pin  
 Print out "Green is set to: "  
 And then the value of Ans

If first letter is b or B...  
 Set integer Ans to number in next part of text  
 Make sure it is between 0 and 255  
 Write that value out to the blue pin  
 Print out "Blue is set to: "  
 And then the value of Ans

Hopefully you can use this 'pseudo-code' to make sure you understand exactly what is going on in this projects code.

We are now going to leave LED's behind for a little while and look at how to control a DC Motor.

# Project 11



Drive a DC Motor

# Project 11 – Drive a DC Motor

We are now going to step away from LED's for a little while and take a look at a different piece of hardware, the DC Motor. In your kit you have been supplied with a standard 1.5 to 4.5 volt DC Motor. In this project you must power the Arduino using the 9v DC Power Supply and NOT the USB cable. Also make sure your diode is the right way around with the white stripe going to +5V.

## Connect it up

### What you will need

DC Motor	
4K7 Potentiometer	
TIP-120 Transistor	
1N4001 Diode	
1KΩ Resistor	
9v Power Supply	

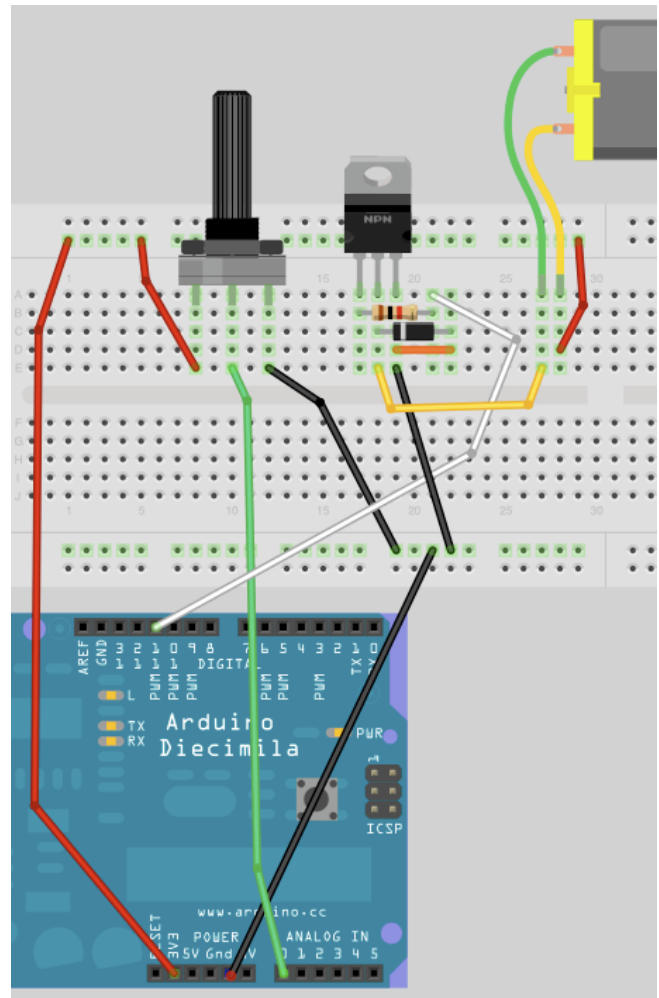

### Enter the code

```
int potPin = 0;           // Analog in 0 connected to the potentiometer
int transistorPin = 11

; // connected to the base of the transistor
int potValue = 0;       // value returned from the potentiometer

void setup() {
  // set the transistor pin as output:
  pinMode(transistorPin, OUTPUT);
}

void loop() {
  // read the potentiometer, convert it to 0 - 255:
  potValue = analogRead(potPin) / 4;
  // use that to control the transistor:
  analogWrite(transistorPin, potValue);
}
```

# Project 11 – Code Overview

Before you power up the circuit, double check that everything has been connected correctly and in particular that the diode is the right way around. Failure to do this can result in permanent damage to your Arduino. Once you are happy that you have wired it all up correctly then go ahead and upload your code.

```
int potPin = 0;
int transistorPin = 11;
int potValue = 0;

void setup() {
  pinMode(transistorPin, OUTPUT);
}

void loop() {
  potValue = analogRead(potPin) / 4;
  analogWrite(transistorPin, potValue);
}
```

This code is very simple indeed. We declare 3 integers that will hold the values of the pin we attach our potentiometer to, the pin we connect the transistor to and the value read from the potentiometer.

In the `setup()` function we set the pinmode of the transistor pin to `put`.

In the main loop `potValue` is set to the value read in from analog pin 0 (the `potPin`) and then divided by 4.





We need to divide the value read in by 4 as the analog value will range from 0 for 0 volts to 1023 for 5 volts. The value we need to write out to the transistor pin can only range from 0 to 255 so we divide the value of analog pin 0 (max 1023) by 4 to give the maximum value of 255 for setting the digital pin 11 (Using `analogWrite` so we are using PWM).

The code then writes out to the transistor pin the value of the pot. In other words, when you rotate the potentiometer, different values ranging from 0 to 1023 are read in and these are converted to the range 0 to 255 and then that value is written out (via PWM) to digital pin 11 which changes the speed of the DC motor. Turn the pot all the way to the left and the motor goes off, turn it to the right and it speeds up until it reaches maximum speed when the pot is turned clockwise all the way.

Now let us find out how our new electronic components introduced in this project work.

# Project 11 – Hardware Overview

The hardware for Project 11 is as below:

DC Motor	
4K7 Potentiometer	
TIP-120 Transistor	
1N4001 Diode	
1KΩ Resistor	
9v Power Supply	

The circuit is essentially split into two sections. Section 1 is our potentiometer, which is connected to +3.3v and Ground with the centre pin going into Analog Pin 0. As the potentiometer is rotated, the resistance changes to allow voltages from 0 to 3.3v to come out of the centre pin, where the value is read using Analog Pin 0.

The second section is what controls the power to the motor. The digital pins on the Arduino give out a maximum of 40mA (milliamps). The 3V DC Motor requires around 500mA to operate at full speed and this is obviously too much for the Arduino. If we were to try to drive the motor directly from a pin on the Arduino serious and permanent damage could occur.

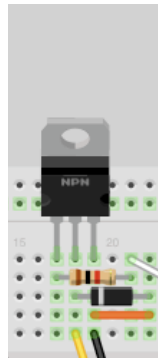

Therefore, we need to find a way to supply it with a higher current. We therefore take power directly from the 3.3v pin on the board, which takes its power in turn from the DC regulator on the board which takes power from our 9v Power Supply. A DC regulator is the larger black object next to the DC in jack and all it does is take the input voltage and reduce it down to 5v. It is good for 800mA of power, which is more than we need for our small DC motor.

However, this project controls the speed of the motor so we need a way to control that voltage to speed up

or slow down the motor. This is where the TIP-120 transistor comes in.

A transistor is essentially a digital switch. It can also be used as a power amplifier. In our circuit we use it as a switch. The electronic symbol for a transistor look like this:

The transistor has 3 legs, one is the Base, one is the Collector and the other the Emitter. These are marked as C, B and E on the diagram.

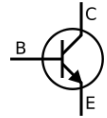

In our circuit we have 3.3 volts going into the Collector via the motor. The Base is connected via a 1KR resistor to Digital Pin 11. The Emitter is connected to Ground. We send pulses via PWM out to Pin 11, and this voltage is reduced using a 1KR resistor. Whenever we apply a voltage to the base, via Pin 11, this makes the transistor turn on allowing current to flow through it from Collector to Emitter and therefore powering the motor that is connected in series with this circuit.

A motor is an electromagnet and it has a magnetic field whilst power is supplied to it. When the power is removed, the magnetic field collapses and this collapsing field can produce a reverse voltage to go back up its wiring. This could seriously damage your Arduino and that is why the diode has been placed the wrong way around on the circuit. The white stripe on the diode normally goes to ground. Power will flow from the positive side to the negative side. As we have it the wrong way around no power will flow down it at all. As we have it across the C and E legs of the transistor this will not impede current flow at all. However, if the motor were to produce a “back EMF” and send current back down the wire, the diode will act as a valve and prevent it from doing so. The diode in our circuit is therefore put in place to protect your Arduino.

# Project 12



Piezo Sounder Melody Player

# Project 12 - Piezo Sounder Melody Player

In this project we are going to use a super simple circuit to produce sounds from our Arduino using a Piezo Sounder.

## Connect it up

### What you will need

Piezo Disc	
Terminal Block	

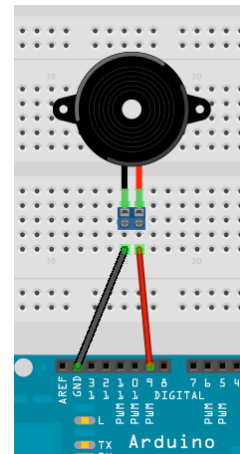

```
(courtesy of http://www.arduino.cc/en/Tutorial/Melody)

// Project 12 - Melody Player
int speakerPin = 9;
int length = 15; // the number of notes
char notes[] = "ccggaagffeeddc "; // a space represents a rest
int beats[] = { 1, 1, 1, 1, 1, 1, 2, 1, 1, 1, 1, 1, 1, 2, 4 };
int tempo = 300;

void playTone(int tone, int duration) {
  for (long i = 0; i < duration * 1000L; i += tone * 2) {
    digitalWrite(speakerPin, HIGH);
    delayMicroseconds(tone);
    digitalWrite(speakerPin, LOW);
    delayMicroseconds(tone);
  }
}

void playNote(char note, int duration) {
  char names[] = { 'c', 'd', 'e', 'f', 'g', 'a', 'b', 'C' };
  int tones[] = { 1915, 1700, 1519, 1432, 1275, 1136, 1014, 956 };
  // play the tone corresponding to the note name
  for (int i = 0; i < 8; i++) {
    if (names[i] == note) {
      playTone(tones[i], duration);
    }
  }
}

void setup() {
  pinMode(speakerPin, OUTPUT);
}

void loop() {
  for (int i = 0; i < length; i++) {
    if (notes[i] == ' ') {
      delay(beats[i] * tempo); // rest
    } else {
      playNote(notes[i], beats[i] * tempo);
    }

    // pause between notes
    delay(tempo / 2);
  }
}
```

When you run this code the Arduino will play a very nice (yeah ok it's terrible) rendition of 'Twinkle Twinkle Little Star'. Sounding very similar to those annoying birthday cards you can buy that play a tune when you open it up.

Let's take a look at this code and see how it works and find out what a piezo disc is.

# Project 12 - Code Overview

In this project we are making sounds using a piezo disc. A piezo disc can do nothing more than make a click when we apply a voltage to it. So to get the tones we can hear out of it we need to make it click many times a second fast enough that it becomes a recognisable note.

The program starts off by setting up the variables we need. The piezo sounders positive (red) cable is attached to Pin 9.

```
int speakerPin = 9;
```

The tune we are going to play is made up of 15 notes.

```
int length = 15; // the number of notes
```

The notes of the tune are stored in a character array as a text string.

```
char notes[] = "ccggaagffeeddc ";
```

Another array, this time of integers, is set up to store the length of each note.

```
int beats[] = { 1, 1, 1, 1, 1, 1, 2, 1, 1, 1, 1, 1, 1, 2, 4 };
```

And finally we set a tempo for the tune to be played at,

```
int tempo = 300;
```

Next you will notice that we declare two functions before our setup() and loop() functions. It doesn't matter if we put our own functions before or after setup() and loop(). When the program runs, the code within these two functions will not run before setup() runs as we have not called those functions yet.

Let's look at the setup and loop functions before we look at the playTone and playNote functions.

All that happens in setup() is we assign the speaker pin (9) as an output.

```
void setup() {
  pinMode(speakerPin, OUTPUT);
}
```

In the main program loop we have an if/else statement inside a for loop.

```
for (int i = 0; i < length; i++) {
  if (notes[i] == ' ') {
    delay(beats[i] * tempo); // rest
  } else {
    playNote(notes[i], beats[i] * tempo);
  }
}
```

As you can see, the first if statement has as its condition, that the array element [i] that the element contains a space character.

```
if (notes[i] == ' ')
```

If this is TRUE then the code within its block is executed.

```
delay(beats[i] * tempo); // rest
```

and this simply works out the value of beats[i] \* tempo and causes a delay of that length to cause a rest in the notes. We then have an else statement.

```
else {
  playNote(notes[i], beats[i] * tempo);
}
```

After an if statement we can extend it with an else statement. An else statement is carried out if the condition within the if statement is false. So, for example. Let's say we had an integer called test and its value was 10 and this if/else statement:

```
if (test == 10) {
  digitalWrite(ledPin, HIGH)
} else {
  digitalWrite(ledPin, LOW)
}
```

Then if 'test' had a value of 10 (which it does) the ledPin would be set to HIGH. If the value of test was anything other than 10, the code within the else statement would be carried out instead and the ledPin would be set to LOW.

The else statement calls a function called playNote and passes two parameters. The first parameter is the value of notes[i] and the second is the value calculated from beats[i] \* tempo.

```
playNote(notes[i], beats[i] * tempo);
```

After if/else statement has been carried out, there is a delay whose value is calculated by dividing tempo by 2.

```
delay(tempo / 2);
```

Let us now take a look at the two functions we have created for this project.



The first function that is called from the main program loop is playNote.

```
void playNote(char note, int duration) {
  char names[] = { 'c', 'd', 'e', 'f', 'g', 'a',
                  'b', 'C' };
  int tones[] = { 1915, 1700, 1519, 1432, 1275,
                 1136, 1014, 956 };
  // play the tone corresponding to the note name
  for (int i = 0; i < 8; i++) {
    if (names[i] == note) {
      playTone(tones[i], duration);
    }
  }
}
```

Two parameters have been passed to the function and within the function these have been given the names note (character) and duration (integer).

The function sets up a local variable array of data type char called 'names'. This variable has local scope so is only visible to this function and not outside of it.

This array stores the names of the notes from middle C to high C.

We then create another array of data type integer and this array stores numbers that correspond to the frequency of the tones, in Kilohertz, of each of the notes in the names[] array.

```
int tones[] = { 1915, 1700, 1519, 1432, 1275,
               1136, 1014, 956 };
```

After setting up the two arrays there is a for loop that looks through the 8 notes in the names[] array and compares it to the note sent to the function.

```
for (int i = 0; i < 8; i++) {
  if (names[i] == note) {
    playTone(tones[i], duration);
  }
}
```

The tune that is sent to this function is 'ccggaagffeeddc' so the first note will be a middle C. The for loop compares that note with the notes in the names[] array and if there is a match, calls up the second function, called playTone, to play the

corresponding tone using in the tones[] array using a note length of 'duration'.

The second function is called playTone.

```
void playTone(int tone, int duration) {
  for (long i = 0; i < duration * 1000L; i +=
tone * 2) {
    digitalWrite(speakerPin, HIGH);
    delayMicroseconds(tone);
    digitalWrite(speakerPin, LOW);
    delayMicroseconds(tone);
  }
}
```

Two parameters are passed to this function. The first is the tone (in kilohertz) that we want the piezo speaker to reproduce and the second is the duration (made up by calculating beats[i] \* tempo).

The function starts a for loop

```
for (long i = 0; i < duration * 1000L; i += tone
* 2)
```

As each for loop must be of a different length to make each note the same length (as the delay differs between clicks to produce the desired frequency) the for loop will run to 'duration' multiplied by 1000 and the increment of the loop is the value of 'tone' multiplied by 2.

Inside the for loop we simply make the pin connected to the piezo speaker go high, wait a short period of time, then go low, then wait another short period of time, then repeat.

```
digitalWrite(speakerPin, HIGH);
delayMicroseconds(tone);
digitalWrite(speakerPin, LOW);
delayMicroseconds(tone);
```

These repetitive clicks, of different lengths and with different pauses (of only microseconds in length) in between clicks, makes the piezo produce a tone of varying frequencies.

# Project 12 - Hardware Overview

The only piece of hardware used in this project is a piezo sounder. This simple device is made up of a thin layer of ceramic bonded to a metallic disc.

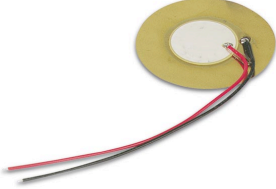

Piezoelectric materials, which are some crystals and ceramics, have the ability to produce electricity when mechanical stress is applied to them. The effect finds useful applications such as the

production and detection of sound, generation of high voltages, electronic frequency generation, microbalances, and ultra fine focusing of optical assemblies.

The effect is also reversible, in that if an electric field is applied across the piezoelectric material it will cause the material to change shape (by as much as 0.1% in some cases).

To produce sounds from a piezo disc, an electric field is turned on and off very fast, to make the material change shape and hence cause a 'click' as the disc pops out and back in again (like a tiny drum). By changing the frequency of the pulses, the disc will deform hundreds or thousands of times per second and hence causing the buzzing sound. By changing the frequency of the clicks and the time in between them, specific notes can be produced.

You can also use the piezo's ability to produce an electric field to measure movement or vibrations.

## Exercise

1. Change the notes and beats to make other tunes such as 'Happy Birthday' or 'Merry Christmas'.
2. Write a program to make a rising and falling tone from the piezo, similar to a car alarm or police siren.

# Project 13

## Serial Temperature Sensor



# Project 13 - Code Overview

We begin by setting variables to store the Analog Pin we will be using and a place to store the temperature read in from the sensor.

```
int potPin = 0;
float temperature = 0;
```

Then in our setup function a Serial object is created running at 9600 baud. A message stating "LM35 Thermometer" is sent to the Serial Monitor (with a newline).

```
void setup()
{
  Serial.begin(9600);
  Serial.println("LM35 Thermometer ");
}
```

Finally, we come across a new command

```
analogReference(INTERNAL);
```

The analogReference command configures the reference voltage used for the analog inputs. When you use an analogRead() function (like we did in Project 6 to read values from a potentiometer), the function will return a value of 1023 for an input equal to the reference voltage.

The options for this function are:

- DEFAULT: the default analog reference of 5 volts
- INTERNAL: an in-built reference, equal to 1.1 volts
- EXTERNAL: the voltage applied to the AREF pin is used as a reference

In our case we have used an internal reference (of 1.1 volts) which means voltages of 1.1v or higher from the temperature sensor will give an analog reading of 1023. Anything lower will give a lower value, e.g. 0.55 volts will give 512.

We use a reference of 1.1v because the maximum voltage out from the LM35DT Temperature Sensor is 1 volt. The sensor can read between 0 Degrees C and 100 Degrees C with 0 Degrees C being an output voltage of 0 volts and 100 Degrees C being a voltage of 1 volt. If we were to not use the INTERNAL setting and leave it at the default (5 volts) then we would be reducing the resolution of the sensor readings as 100 Degrees C would only be using 20% of the resolution of the Arduino's ADC (Analog to Digital Convertor) which can convert analog voltages between 0 and 5 volts into digital readings between 0 and 1023.

Next we create a function called printTenths (remember we can put functions before or after setup and loop).

```
void printTenths(int value) {
  // prints a value of 123 as 12.3
  Serial.print(value / 10);
  Serial.print(".");
  Serial.println(value % 10);
}
```

This function is designed to turn the integer values from analog pin 0 and show the fractions of a degree. The Arduino's ADC reads values between 0 and 1023. Our reference voltage is 1.1 volts and so the maximum reading we will get (at 100 Degrees C) will be 931 (1024/1.1). Each of the 1024 values from the ADC increment in steps of 0.00107421875 volts (or just over 1 millivolt). The value from the ADC is an integer value so the printTenths function is designed to show the fraction part of the temperature reading.

We pass the function an integer 'value', which will be the reading from the temperature sensor. The function prints the value divided by 10. E.g. If the reading were 310, this would equate to 33.3 degrees (remember 100 Degrees C is a reading of 931 and 1/3 of that is 310 (the value passed to printTenths is worked out in the main loop and we will come to see how that is calculated shortly).

When the `Serial.print(value / 10)` command prints out 33.3, it will only print the 33 part of that number as the variable 'value' is an integer and therefore unable to store fractions of 1. The program then prints a decimal point after the whole number `Serial.print(".");`

Finally, we print out what is after the decimal point using the modulo (%) command. The modulo command works out the remainder when one integer is divided by another. In this case we calculate `value % 10` which divides 'value' by 10, but gives us the remainder instead of the quotient. This is a clever way of printing a floating pointer number, which was derived from an integer value.

Let's now take a look at the main loop of the program and see what is going on here.

```

void loop() {
  int span = 20;
  int aRead = 0;
  for (int i = 0; i < span; i++) {
    aRead = aRead+analogRead(potPin);
  }
  aRead = aRead / 20;

  temperature = ((100*1.1*aRead)/1024)*10;
  // convert voltage to temperature
  Serial.print("Analog in reading: ");
  Serial.print(long(aRead));
  // print temperature value on serial
  monitor
  Serial.print(" - Calculated Temp: ");
  printTenths(long(temperature));

  delay(500);
}

```

The start of the loop sets up two local variables (variables whose 'scope', or visibility, is only between the curly braces of the function it is within) called 'span' and 'aRead'. A for loop is then set up to loop between zero and 20 (or whatever value is stored in the 'span' variable). Within the for loop the value read in from analogPin(0) is added to the value stored in aRead.

```

for (int i = 0; i < span; i++) {
  aRead = aRead+analogRead(potPin);
}
aRead = aRead / 20;

```

The, after the for loop, the total value of aRead is divided by 20 (or whatever value is stored in 'span'). This gives us an average value read in from the temperature sensor, averaged out over 20 consecutive readings. The reason we do that is because analog devices, such as our temperature sensor, are prone to fluctuations caused by electrical noise in the circuit, interference, etc. and therefore each reading, out of a set of 20, will differ slightly. To give a more accurate reading, we take 20 values from the sensor and then average them out to give us a more accurate reading. The readings are taken one after the other, without any delay and therefore it will take only a tiny fraction of a second for the Arduino to perform this task.

We now have an averaged reading from the analogPin connected to the temperature sensor, which will be some value between 0 and 930 (0 to 100 degrees C respectively). That value now needs to be converted into a temperature in degrees C and the next line performs that function:

```
temperature = ((100*1.1*aRead)/1024)*10;
```

This calculation multiplies the value from the digital pin by 1.1 (our reference voltage) and again by 100. What this does is stretch out or values from 0 to 930 to be a

value between 0 and 1023 ( $100 \times 1.1 \times aRead$ ). This value is then divided by 1024 to give us a maximum value of 100, which in turn is multiplied by 10 to add an extra digit to the end, enabling the modulo function to work.

Let's look at that calculation step by step. Let us presume, for example, that the temperature being read is 50 degrees C. As we are using a reference voltage of 1.1 volts, our maximum value from the sensor will be 930 as the sensor's maximum output voltage is 1 volt. 50 Degrees C will therefore be half of that, or 465.

If we put that value into our equation we get :-

$$(100 * 1.1 * 465.5) = 51205$$

$$51205 / 1024 = 50$$

$$50 * 10 = 500$$

When passed to the printTenths() function we will get a temperature of 50.0

Let's try another example. The temperature is 23.5 Degrees C. This will be read as a value of 219

$$(100 * 1.1 * 219) = 24090$$

$$24090 / 1024 = 23.525$$

$$23.525 * 10 = 235$$

When passed to the printTenths() function we get 23.5

After we have calculated the temperature, the program then prints out "Analog in reading: : to the Serial Monitor, then displays the value of aRead followed by "Calculated Temp: " and the value stored in 'temperature'. (passed to the printTenths function).

The value of 'temperature' has the word long before it when we pass it to printTenths. This is an example of 'casting' or forcing one variable type to become another. The printTenths function is expecting an integer, we pass it a long type instead. Any values after the decimal point are truncated (ignored).

E.g.

```

int i;
float f;

f = 3.6;
i = (int) f; // now i is 3

```

In this example we have cast the floating point variable f into an integer.

Finally the program delays half a second and then repeats.

# Project 13 - Hardware Overview

The hardware used for this project is very simply a LM35DT Temperature Sensor and 3 wires.

The LM35DT is an analogue temperature sensor that can read from 0 to 100 Degrees C and is accurate to within 0.5 degrees.

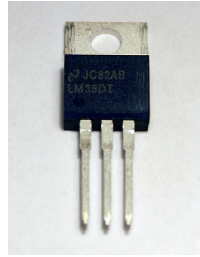

The device requires a power supply of anywhere between 4 to 30V DC. The output from the LM35DT will be dependent on input voltage. In our case we are giving the device 5V from the Arduino and therefore 0 Degrees C will give an output voltage of 0 volts. 100 Degrees C will give the maximum output voltage (which will match the input voltage) of 5 volts.

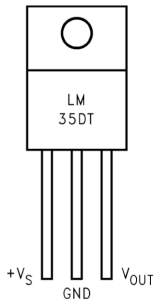

If we take a look at the diagram of the pinouts from the LM35DT datasheet, you can see that there are 3 legs to the device. The left hand leg (with the device number facing you and heatsink away from you) is the input voltage. The middle leg goes to ground and the right hand leg gives you the output voltage, which will be your temperature reading.

# Project 14





Light Sensor

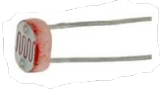

# Project 14 - Light Sensor

In this project we are going to use the Light Dependent Resistor in our kit to read values from it and output them to the Serial Monitor.

## What you will need

Light Dependent Resistor	
100Ω Resistor	
3 x 1K5Ω Resistors	
Green LED	

## Connect it up

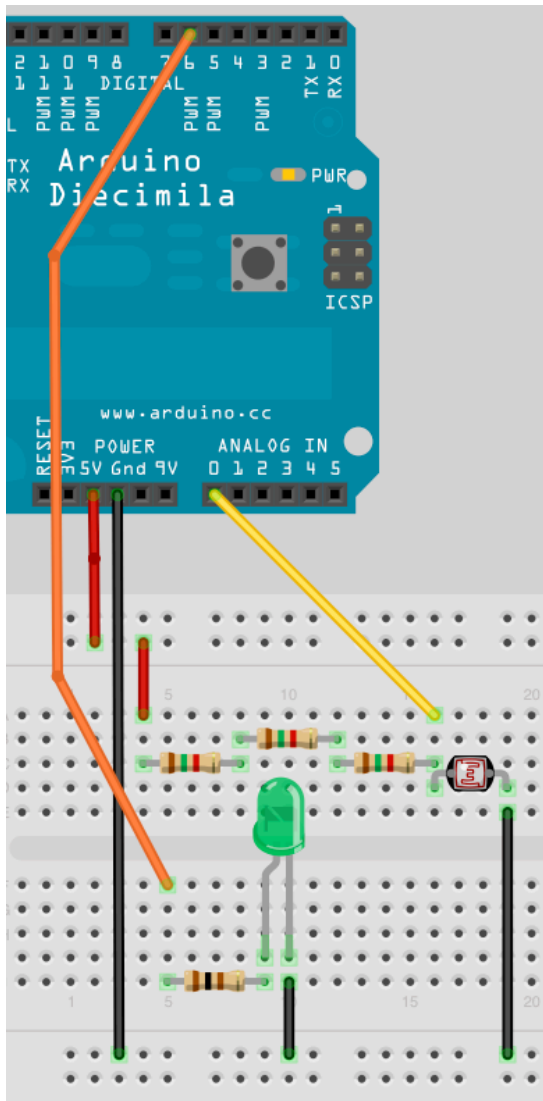

## Enter the Code

Enter the code, then upload it to your Arduino. You will see the LED flashing on and off. If you cover the LDR (Light Dependent Resistor) you will see the LED flash slower. Now shine a bright light onto the LDR and you will see it flash faster.

```
//Project 14 - Light Sensor

// Pin we will connect to LED
int ledPin = 6;
// Pin connected to LDR
int ldrPin = 0;
// Value read from LDR
int lightVal = 0;

void setup()
{
    // Set both pins as outputs
    pinMode(ledPin, OUTPUT);
}

void loop()
{
    // Read in value from LDR
    lightVal = analogRead(ldrPin);
    // Turn LED on
    digitalWrite(ledPin, HIGH);
    // Delay of length lightVal
    delay(lightVal);
    // Turn LED off
    digitalWrite(ledPin, LOW);
    // Delay again
    delay(lightVal);
}
```

# Project 14 – Code Overview

This code is pretty simple and you should be able to work out what it does yourself by now.

The code starts off by initialising variables related to Digital Pin 6, which the LED is connected to and Analogue Pin 0, which the LDR is connect to. We also initialise a variable called lightVal which will store the values red in from the LDR.

```
int ledPin = 6;
// Pin connected to LDR
int ldrPin = 0;
// Value read from LDR
int lightVal = 0;
```

The setup function sets the pinmode of the LED pin to output.

```
pinMode(ledPin, OUTPUT);
```

In the main loop of the program we read in analog value from Analog Pin 0 and store it in the 'lightVal' variable.

```
lightVal = analogRead(ldrPin);
```

Then the LED is turned on and off, with a delay equal to the value read in from the analog pin.

```
digitalWrite(ledPin, HIGH);
delay(lightVal);
digitalWrite(ledPin, LOW);
delay(lightVal);
```

As more light falls on the LDR the value read in from Analog Pin 0 decreases and the LED flashes faster.

Let's find out how this circuit works.

# Project 14 - Hardware Overview

The only additional component used in this circuit is the LDR or Light Dependent Resistor (sometimes called a photoresistor). An LDR initially has a very high resistance. But, as light falls on it, the resistance will drop, allowing more current through.

Our LDR is connected in series with 3 x 1.5KΩ Resistors and the input into Analog Pin 0 is between these 2. This is what is known as a voltage divider. We will explain this in a second.



The 3 x 1.5K give a total resistance of 4500Ω (4.5KΩ). Resistors in series have a resistance equal to the sum of their individual resistances. In this case the value is 3 x 1500 = 4500.

A voltage divider is a circuit consisting of two resistances across a voltage supply. An output between the two resistances will give a lower voltage depending on the values of the two resistors.

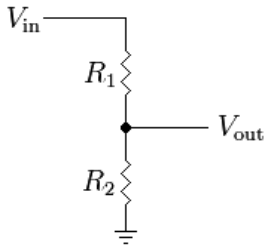

The diagram on the left shows a voltage divider made up of two resistors. The value of Vout will be lower than the value of Vin.

To work out the value of Vout we use the following calculation:

$$V_{out} = \frac{R_2}{R_1 + R_2} V_{in}$$

We are providing 5 volts into the circuit so let's work out what values we will get out. Using a multimeter I have measured the resistance from the LDR in different conditions.

Conditions	Resistance
LDR Covered by Finger	8KΩ
Light in room (overcast day)	1KΩ
Held under a bright light	150Ω

So using these values of resistance, the input voltage and the calculation we listed above, the approx. output voltage can be calculated thus:

V <sub>in</sub>	R <sub>1</sub>	R <sub>2</sub>	V <sub>out</sub>
5v	4500Ω	8000Ω	3.2v
5v	4500Ω	1000Ω	0.9v
5v	4500Ω	150Ω	0.16v

As you can see, as the resistance of the LDR (R<sub>2</sub>) decreases, the voltage out of the voltage divider decreases also, making the value read in from the Analog Pin lower and therefore decreasing the delay making the LED flash faster.

A voltage divider circuit could also be used for decreasing a voltage to a lower one if you used 2 standard resistors, rather than a resistor and an LDR (which is a variable resistor). Alternatively, you could use a potentiometer so you can adjust the voltage out by turning the knob.

# Project 15



Shift Register 8-Bit Binary Counter

# Project 15 - Shift Register 8-Bit Binary Counter

Right, we are now going to delve into some pretty advanced stuff so you might want a stiff drink before going any further.

In this project we are going to use additional IC's (Integrated Circuits) in the form of Shift Registers, to enable us to drive LED's to count in Binary (we will explain what binary is soon). In this project we will drive 8 LED's independently using just 3 output pins from the Arduino.

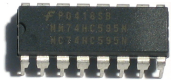
## What you will need

1 x 74HC595 Shift Registers	
8 x 240Ω Resistor	
8 x Green LED	

## Connect it up



Examine the diagram carefully. Connect the 3.3v to the top rail of your Breadboard and the Ground to the bottom. The chip has a small dimple on one end, this dimple goes to the left. Pin 1 is below the dimple, Pin 8 at bottom right, Pin 9 at top right

and Pin 16 at top left.

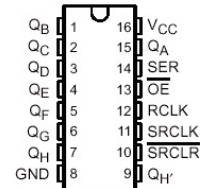

You now need wires to go from the 3.3v supply to Pins 9 & 16. Also, wires from Ground to Pins 8 & 13.

A wire goes from Digital Pin 8 to Pin 12 on the IC. Another one goes from Digital Pin 10 to Pin 14 and finally one from Digital Pin 12 to Pin 11.

The 8 LED's have a 240Ω resistor between the cathode and ground, then the anode of LED 1 goes to Pin 15. The anode of LED's 2 to 8 goes to Pins 1 to 7 on the IC.

Once you have connected everything up, have one final check your wiring is correct and the IC and LED's are the right way around. Then enter the following code. Remember, if you don't want to enter the code by hand you can download it from the website on the same page you obtained this book.

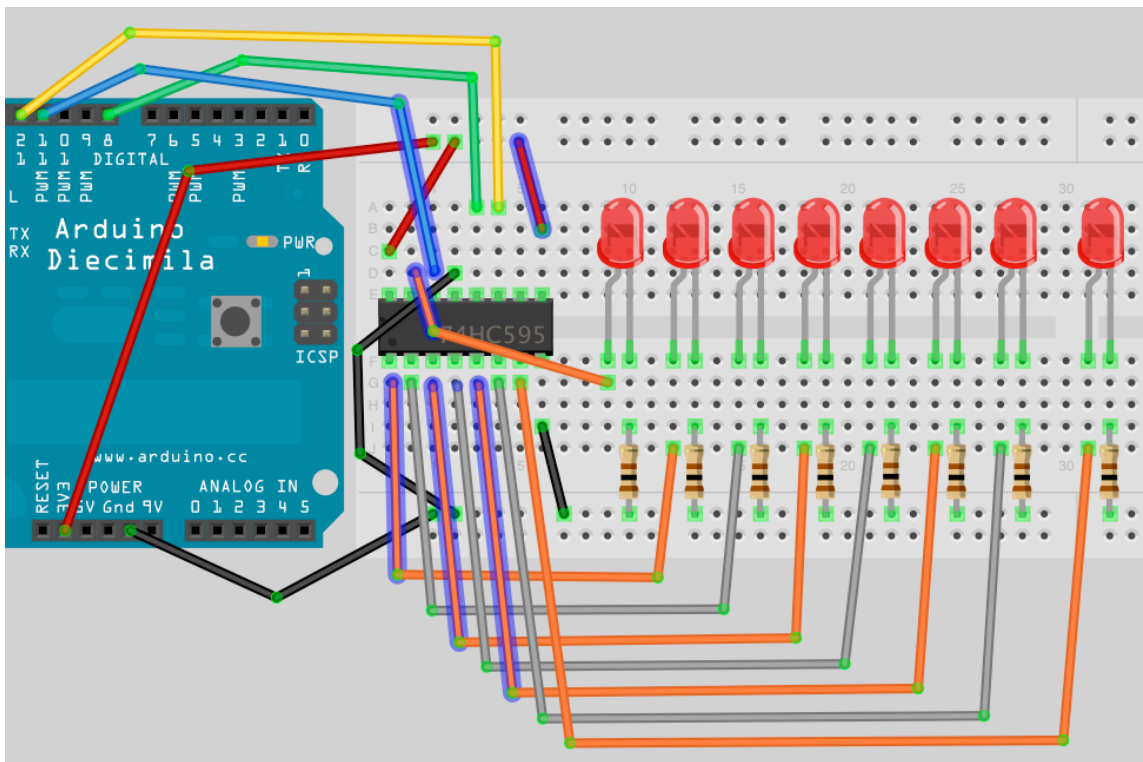

## Enter the Code

Enter the following code and upload it to your Arduino. Once the code is run you will see the LED's turn on and off individually as the LED's count up in Binary from 0 to 255, then start again.

```
// Project 15

//Pin connected to Pin 12 of 74HC595 (Latch)
int latchPin = 8;
//Pin connected to Pin 11 of 74HC595 (Clock)
int clockPin = 12;
//Pin connected to Pin 14 of 74HC595 (Data)
int dataPin = 11;

void setup() {
  //set pins to output
  pinMode(latchPin, OUTPUT);
  pinMode(clockPin, OUTPUT);
  pinMode(dataPin, OUTPUT);
}

void loop() {
  //count from 0 to 255
  for (int i = 0; i < 256; i++) {
    //set latchPin low to allow data flow
    digitalWrite(latchPin, LOW);
    shiftOut(i);
    //set latchPin to high to lock and send data
    digitalWrite(latchPin, HIGH);
    delay(500);
  }
}

void shiftOut(byte dataOut) {
  // Shift out 8 bits LSB first,
  // on rising edge of clock

  boolean pinState;

  //clear shift register ready for
  sending data
  digitalWrite(dataPin, LOW);
  digitalWrite(clockPin, LOW);
  // for each bit in dataOut send out
```

```
a bit
  for (int i=0; i<=7; i++) {
    //set clockPin to LOW prior to sending bit
    digitalWrite(clockPin, LOW);

    // if the value of DataOut and (logical
    AND) a bitmask
    // are true, set pinState to 1 (HIGH)
    if ( dataOut & (1<<i) ) {
      pinState = HIGH;
    }
    else {
      pinState = LOW;
    }

    //sets dataPin to HIGH or LOW depending on
    pinState
    digitalWrite(dataPin, pinState);
    //send bit out on rising edge of clock
    digitalWrite(clockPin, HIGH);
  }

  //stop shifting out data
  digitalWrite(clockPin, LOW);
}
```

# The Binary Number System

Now before we take a look at the code and the hardware for Project 15, it is time to take a look at the Binary Number System, as it is essential to understand Binary to be able to successfully program a microcontroller.

Human beings use a Base 10, or Decimal number system, because we have 10 fingers on our hands. Computers do not have fingers and so the best way for a computer to count is using it's equivalent of fingers, which is a state of either ON or OFF (1 or 0). A logic device, such as a computer, can detect if a voltage is there (1) or if it is not (0) and so uses a binary, or base 2 number system as this number system can easily be represented in an electronic circuit with a high or low voltage state.

In our number system, base 10, we have 10 digits ranging from 0 to 9. When we count to the next digit after 9 the digit resets back to zero, but a 1 is incremented to the tens column to its left. Once the tens column reaches 9, incrementing this by 1 will reset it to zero, but add 1 to the hundreds column to it's left, and so on.

000, 001, 002, 003, 004, 005, 006, 007, 008, 009  
010, 011, 012, 013, 014, 015, 016, 017, 018, 019  
020, 021, 023 .....

In Binary the exact same thing happens, except the highest digit is 1 so adding 1 to 1 results in the digit resetting to zero and 1 being added to the column to the left.

000, 001  
010, 011  
100, 101...

An 8 bit number (or a byte) is represented like this

2 <sup>7</sup> 128	2 <sup>6</sup> 64	2 <sup>5</sup> 32	2 <sup>4</sup> 16	2 <sup>3</sup> 8	2 <sup>2</sup> 4	2 <sup>1</sup> 2	2 <sup>0</sup> 1
0	1	0	0	1	0	1	1

The number above in Binary is 1001011 and in Decimal this is 75.

This is worked out like this :

1 x 1 = 1  
1 x 2 = 2  
1 x 8 = 8  
1 x 64 = 64

Add that all together and you get 75.

Here are some other examples:

Dec	2 <sup>7</sup> 128	2 <sup>6</sup> 64	2 <sup>5</sup> 32	2 <sup>4</sup> 16	2 <sup>3</sup> 8	2 <sup>2</sup> 4	2 <sup>1</sup> 2	2 <sup>0</sup> 1
75	0	1	0	0	1	0	1	1
1	0	0	0	0	0	0	0	1
2	0	0	0	0	0	0	1	0
3	0	0	0	0	0	0	1	1
4	0	0	0	0	0	1	0	0
12	0	0	0	0	1	1	0	0
27	0	0	0	1	1	0	1	1
100	0	1	1	0	0	1	0	0
127	0	1	1	1	1	1	1	1
255	1	1	1	1	1	1	1	1

...and so on.

So now that you understand binary (or at least I hope you do) we will first take a look at the hardware, before looking at the code.

## TOP TIP

You can use Google to convert between a Decimal and a Binary number and vice versa.

E.g to convert 171 Decimal to Binary type

**171 in Binary**

Into the Google search box returns

**171 = 0b10101011**

The 0b prefix shows the number is a Binary number and not a Decimal number.

So the answer is 10101011.

To convert a Binary number to decimal do the reverse. E.g. Enter

**0b11001100 in Decimal**

Into the search box returns

**0b11001100 = 204**

# Project 15 - Hardware Overview

We are going to do things the other way around for this project and take a look at the hardware before we look at the code.

We are using a Shift Register. Specifically the 74HC595 type of Shift Register. This type of Shift Register is an 8-bit serial-in, serial or parallel-out shift register with output latches. This means that you can send data in to the Shift Register in series and send it out in parallel. In series means 1 bit at a time. Parallel means lots of bits (in this case 8) at a time. So you give the Shift Register data (in the form of 1's and 0's) one bit at a time, then send out 8 bits all at the exact same time. Each bit is shunted along as the next bit is entered. If a 9th bit is entered before the Latch is set to HIGH then the first bit entered will be shunted off the end of the row and be lost forever.

Shift Registers are usually used for serial to parallel data conversion. In our case, as the data that is output is 1's and 0's (or 0v and 3.3v) we can use it to turn on and off a bank of 8 LED's.

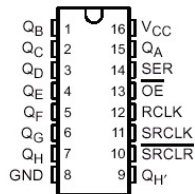

The Shift Register, for this project, requires only 3 inputs from the Arduino. The outputs of the Arduino and the inputs of the 595 are as follows:

Arduino Pin	595 Pin	Description
8	12	Storage Register Clock Input
11	14	Serial Data Input
12	11	Shift Register Clock Input

We are going to refer to Pin 12 as the Clock Pin, Pin 14 as the Data Pin and Pin 11 as the Latch Pin.

Imagine the Latch as a gate that will allow data to escape from the 595. When the gate is lowered (LOW) the data in the 595 cannot get out, but data can be entered. When the gate is raised (HIGH) data can no longer be entered, but the data in the Shift Register is

released to the 8 Pins (QA-QH). The Clock is simply a pulse of 0's and 1's and the Data Pin is where we send data from the Arduino to the 595.

To use the Shift Register the Latch Pin and Clock Pin must be set to LOW. The Latch Pin will remain at LOW until all 8 bits have been set. This allows data to be entered into the Storage Register (the storage register is simply a place inside the IC for storing a 1 or a 0). We then present either a HIGH or LOW signal at the Data Pin and then set the Clock Pin to HIGH. By setting the Clock Pin to HIGH this stores the data presented at the Data Pin into the Storage Register. Once this is done we set the Clock to LOW again, then present the next bit of data at the Data Pin. Once we have done this 8 times, we have sent a full 8 bit number into the 595. The Latch Pin is now raised which transfers the data from the Storage Register into the Shift Register and outputs it from QA to QH (Pin 15, 1 to 7).

I have connected a Logic Analyser (a device that lets you see the 1's and 0's coming out of a digital device) to my 595 whilst this program is running and the image at the bottom of the page shows the output.

The sequence of events here is:

Pin	State	Description
Latch	LOW	Latch lowered to allow data to be entered
Data	HIGH	First bit of data (1)
Clock	HIGH	Clock goes HIGH. Data stored.
Clock	LOW	Ready for next Bit. Prevent any new data.
Data	HIGH	2nd bit of data (1)
Clock	HIGH	2nd bit stored
...	...	...
Data	LOW	8th bit of data (0)
Clock	HIGH	Store the data
Clock	LOW	Prevent any new data being stored
Latch	HIGH	Send 8 bits out in parallel

In the image below, you can see that the binary number 00110111 (reading from right to left) or Decimal 55 has been sent to the chip.

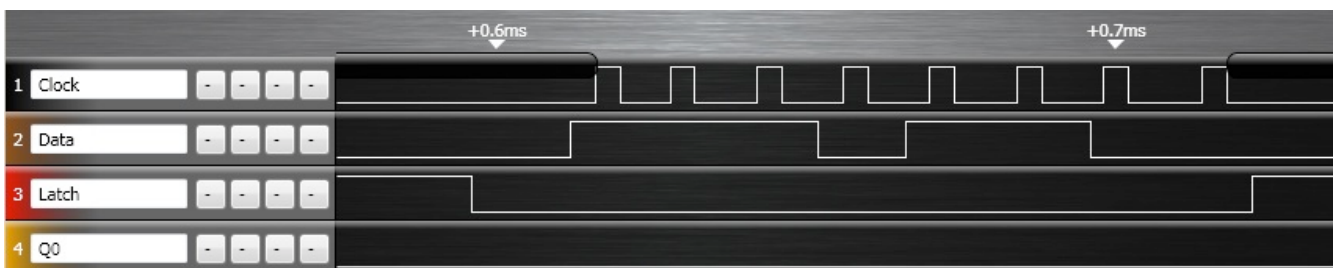



So to summarise the use of a single Shift Register in this project, we have 8 LED's attached to the 8 outputs of the Register. The Latch is set to LOW to enable data entry. Data is sent to the Data Pin, one bit at a time, the CLock Pin is set to HIGH to store that data, then back down to low ready for the next bit. After all 8 bits have been entered, the latch is set to HIGH which prevents further data entry and sets the 8 output pins to either High (3.3v or LOW (0 volts) depending on the state of the Register.

If you want to read up more about the shift register you have in your kit, then take a look at the serial number on the IC (e.g. 74HC595N or SN74HC595N, etc.) and enter that into Google. You can then find the specific datasheet for the IC and read more about it.

I'm a huge fan of the 595 chip. It is very versatile and can of course increase the number of digital output pins that the Arduino has. The standard Arduino has 19 Digital Outputs (the 6 Analog Pins can also be used as Digital Pins numbered 14 to 19). Using 8-bit Shift Registers you can expand that to 49 (6 x 595's plus one spare pin left over). They also operate very fast, typically at 100MHz. Meaning you can send data out at approx. 100 million times per second if you wanted to. This means you can also send PWM signals via software to the IC's and enable brightness control of the LED's too.

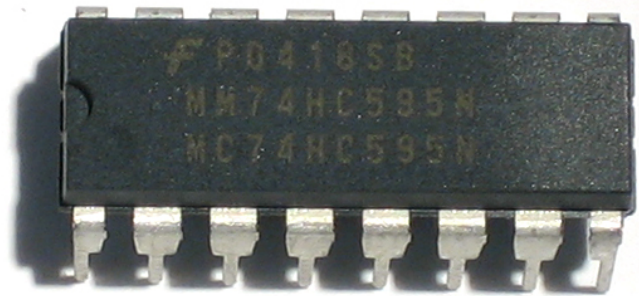

As the outputs are simply ON's and OFF's of an output voltage, they can also be used to switch other low powered (or even high powered devices with the use of transistors or relays) devices on and off or to send data to devices (e.g. An old dot matrix printer or other serial device).

All of the 595 Shift Registers from any manufacturer are just about identical to each other. There are also larger Shift Registers with 16 outputs or higher. Some IC's advertised as LED Driver Chips are, when you examine the datasheet, simply larger Shift Registers (e.g. The M5450 and M5451 from STMicroelectronics).

# Project 15 - Code Overview

The code for Project 15 looks pretty daunting at first look. But when you break it down into it's component parts.

First, 3 variables are initialised for the 3 pins we are going to use.

```
int latchPin = 8;
int clockPin = 12;
int dataPin = 11;
```

Then, in setup, the pins are all set to Outputs.

```
pinMode(latchPin, OUTPUT);
pinMode(clockPin, OUTPUT);
pinMode(dataPin, OUTPUT);
```

The main loop simply runs a for loop counting from 0 to 255. On each iteration of the loop the latchPin is set to LOW to enable data entry, then the function called shiftOut is called, passing the value of i in the for loop to the function. Then the latchpin is set to HIGH, preventing further data entry and setting the outputs from the 8 pins. Finally there is a delay of half a second before the next iteration of the loop commences.

```
void loop() {
  //count from 0 to 255
  for (int i = 0; i < 256; i++) {
    //set latchPin low to allow data flow
    digitalWrite(latchPin, LOW);
    shiftOut(i);
    //set latchPin to high to lock and send
    data
    digitalWrite(latchPin, HIGH);
    delay(500);
  }
}
```

The shiftOut function receives as a parameter a Byte (8 bit number), which will be our number between 0 and 255. We have chosen a Byte for this usage as it is exactly 8 bits in length and we need to send only 8 bits out to the Shift Register.

```
void shiftOut(byte dataOut) {
```

Then a boolean variable called pinState is initialised. This will store the state we wish the relevant pin to be in when the data is sent out (1 or 0).

```
boolean pinState;
```

The Data and Clock pins are set to LOW to reset the data and clock lines ready for fresh data to be sent.

```
digitalWrite(dataPin, LOW);
digitalWrite(clockPin, LOW);
```

After this, we are ready to send the 8 bits in series to the 595 one bit at a time.

A for loop that iterates 8 times is set up.

```
for (int i=0; i<=7; i++) {
```

The clock pin is set low prior to sending a Data bit.

```
digitalWrite(clockPin, LOW);
```

Now an if/else statement determines if the pinState variable should be set to a 1 or a 0.

```
if ( dataOut & (1<<i) ) {
  pinState = HIGH;
}
else {
  pinState = LOW;
}
```

The condition for the if statement is:

```
dataOut & (1<<i).
```

This is an example of what is called a 'bitmask' and we are now using Bitwise Operators. These are logical operators similar to the Boolean Operators we used in previous projects. However, the Bitwise Operators act on number at the bit level.

In this case we are using the Bitwise and (&) operator to carry out a logical operation on two numbers. The first number is dataOut and the second is the result of (1<<i). Before we go any further let's take a look at the Bitwise Operators.

# Bitwise Operators

The Bitwise Operators perform calculations at the bit level on variables. There are 6 common Bitwise Operators and these are:

```
&    Bitwise and
|    Bitwise or
^    Bitwise xor
~    Bitwise not
<<  Bitshift left
>>  Bitshift right
```

Bitwise Operators can only be used between integers. Each operator performs a calculation based on a set of logic rules. Let us take a close look at the Bitwise AND (&) Operator.

## Bitwise AND (&)

The Bitwise AND operator act according to this rule:-

*If both inputs are 1, the resulting outputs are 1, otherwise the output is 0.*

Another way of looking at this is:

```
0 0 1 1    Operand1
0 1 0 1    Operand2
-----
0 0 0 1    (Operand1 & Operand2)
```

A type int is a 16-bit value, so using & between two int expressions causes 16 simultaneous AND operations to occur. In a section of code like this:

```
int x = 77;    //binary: 0000000001001101
int y = 121;  //binary: 0000000001111001
int z = x & y; //result: 0000000001001001
```

Or in this case  $77 \& 121 = 73$

The remaining operators are:

## Bitwise OR (|)

If either or both of the inputs is 1, the result is 1, otherwise it is 0.

```
0 0 1 1    Operand1
0 1 0 1    Operand2
-----
0 1 1 1    (Operand1 | Operand2)
```

## Bitwise XOR (^)

*If only 1 of the inputs is 1, then the output is 1. If both inputs are 1, then the output 0.*

```
0 0 1 1    Operand1
0 1 0 1    Operand2
-----
0 1 1 0    (Operand1 ^ Operand2)
```

## Bitwise NOT (~)

The Bitwise NOT Operator is applied to a single operand to its right.

*The output becomes the opposite of the input.*

```
0 0 1 1    Operand1
-----
1 1 0 0    ~Operand1
```

## Bitshift Left (<<), Bitshift Right (>>)

The Bitshift operators move all of the bits in the integer to the left or right the number of bits specified by the right operand.

variable << number\_of\_bits

E.g.

```
byte x=9; // binary: 00001001
byte y=x<<3; //binary: 01001000 (or 72 dec)
```

Any bits shifted off the end of the row are lost forever. You can use the left bitshift to multiply a number by powers of 2 and the right bitshift to divide by powers of 2 (work it out).

Now that we have taken a look at the Bitshift Operators let's return to our code.

# Project 15 - Code Overview (continued)

The condition of the if/else statement was

```
dataOut & (1<<i)
```

And we now know this is a Bitwise AND (&) operation. The right hand operand inside the parenthesis is a left bitshift operation. This is a 'bitmask'. The 74HC595 will only accept data one bit at a time. We therefore need to convert the 8 bit number in dataOut into a single bit number representing each of the 8 bits in turn. The bitmask allows us to ensure that the pinState variable is set to either a 1 or a 0 depending on what the result of the bitmask calculation is. The right hand operand is the number 1 bit shifted i number of times. As the for loop makes the value of i go from 0 to 7 we can see that 1 bitshifted i times, each time through the loop, will result in these binary numbers:

Value of I	Result of (1<<i) in Binary
0	00000001
1	00000010
2	00000100
3	00001000
4	00010000
5	00100000
6	01000000
7	10000000

So you can see that the 1 moves from right to left as a result of this operation.

Now the & operator's rules state that

*If both inputs are 1, the resulting outputs are 1, otherwise the output is 0.*

So, the condition of

```
dataOut & (1<<i)
```

will result in a 1 if the corresponding bit in the same place as the bitmask is a 1, otherwise it will be a zero. For example, if the value of dataOut was Decimal 139 or 10001011 binary. Then each iteration through the loop will result in

Value of I	Result of b10001011(1<<i) in Binary
0	00000001
1	00000010
2	00000000
3	00001000
4	00000000

Value of I	Result of b10001011(1<<i) in Binary
5	00000000
6	00000000
7	10000000

So every time there is a 1 in the I position (reading from right to left) the value comes out at higher than 1 (or TRUE) and every time there is a 0 in the I position, the value comes out at 0 (or FALSE).

The if condition will therefore carry out its code in the block if the value is higher than 0 (or in other words if the bit in that position is a 1) or 'else' (if the bit in that position is a 0) it will carry out the code in the else block.

So looking at the if/else statement once more

```
if ( dataOut & (1<<i) ) {
    pinState = HIGH;
}
else {
    pinState = LOW;
}
```

And cross referenciong this with the truth table above, we can see that for every bit in the value of dataOut that has the value of 1 that pinState will be set to HIGH and for every value of 0 it will be set to LOW.

The next piece of code writes either a HIGH or LOW state to the Data Pin and then sets the Clock Pin to HIGH to write that bit into the storage register.

```
digitalWrite(dataPin, pinState);
digitalWrite(clockPin, HIGH);
```

Finally the Clock Pin is set to low to ensure no further bit writes.

```
digitalWrite(clockPin, LOW);
```

So, in simple terms, this section of code looks at each of the 8 bits of the value in dataOut one by one and sets the data pin to HIGH or LOW accordingly, then writes that value into the storage register.

This is simply sending the 8 bit number out to the 595 one bit at a time and then the main loop sets the Latch Pin to HIGH to send out those 8 bits simultaneously to Pins 15 and 1 to 7 (QA to QH) of the Shift Register, thus making our 8 LED's show a visual representation of the binary number stored in the Shift Register.



# Project 16

Dual 8-Bit Binary Counters

# Project 16 - Dual 8-Bit Binary Counters

In Project 16 we will daisy chain another 74HC595 IC onto the one used in Project 15 to create a dual binary counter.

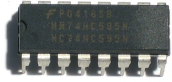
## What you will need

2 x 74HC595 Shift Registers	
8 x 240Ω Resistor	
8 x Red LED	

## Connect it up

The first 595 is wired the same as in Project 15. The 2nd 595 has +5v and Ground wires going to the same pins as on the 1st 595. Then, add a wire from Pin 9 on IC 1 to Pin 14 on IC 2. Add another from Pin 11 on IC 1 to Pin 11 on IC 2 and Pin 12 on IC 1 to Pin 12 on IC 2.

The same outputs as on the 1st 595 going to the first set of LED's go from the 2nd IC to the 2nd set of LED's.

Examine the diagrams carefully.

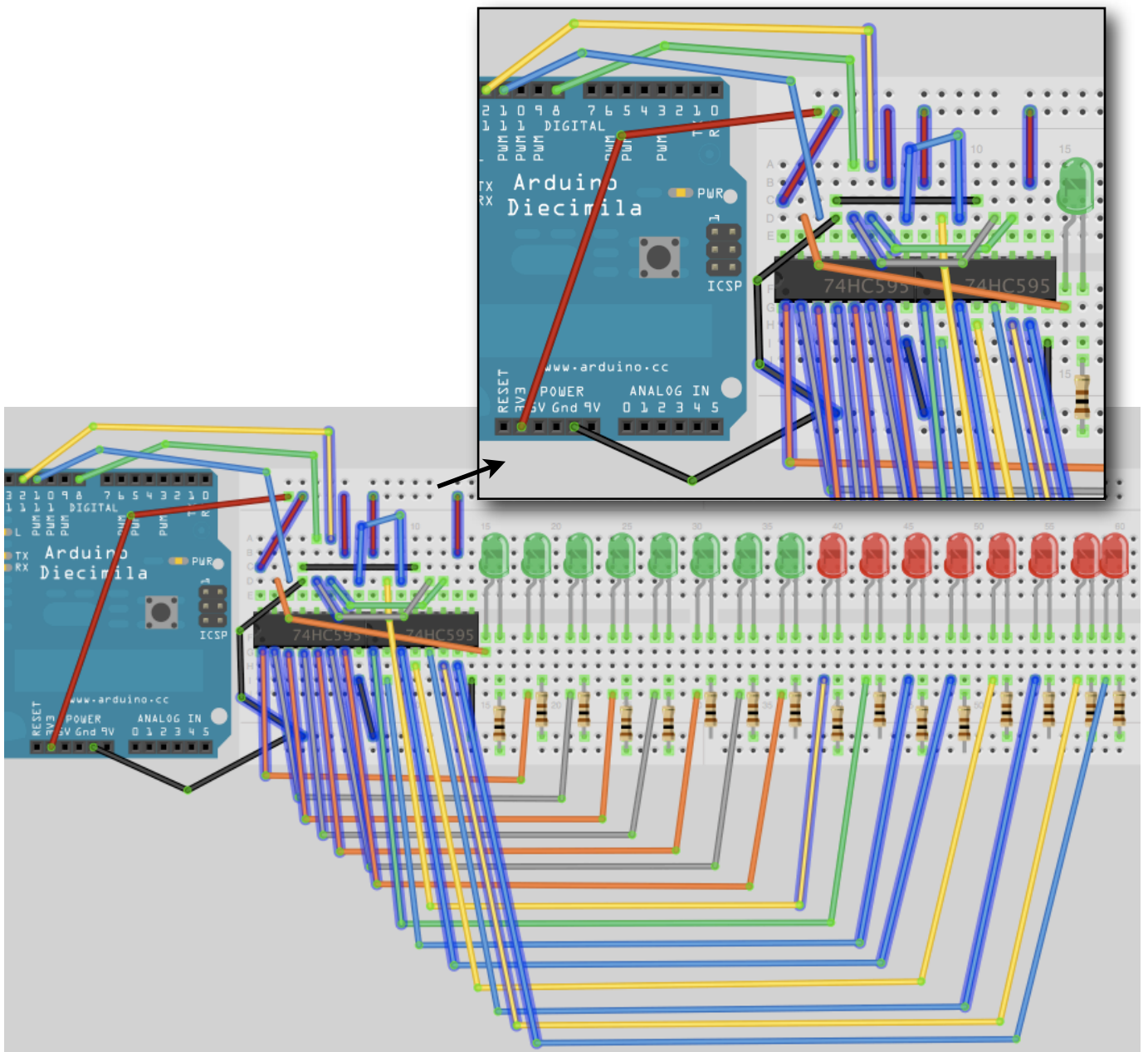

## Enter the Code

Enter the following code and upload it to your Arduino.

When you run this code you will see the Red set of LED's count up (in Binary) from 0 to 255 and the Green LED's count down from 255 to 0 at the same time.

```
// Project 16

//Pin connected to Pin 12 of 74HC595 (Latch)
int latchPin = 8;
//Pin connected to Pin 11 of 74HC595 (Clock)
int clockPin = 12;
//Pin connected to Pin 14 of 74HC595 (Data)
int dataPin = 11;

void setup() {
  //set pins to output
  pinMode(latchPin, OUTPUT);
  pinMode(clockPin, OUTPUT);
  pinMode(dataPin, OUTPUT);
}

void loop() {
  //count from 0 to 255
  for (int i = 0; i < 255; i++) {
    //set latchPin low to allow data flow
    digitalWrite(latchPin, LOW);
    shiftOut(i);
    shiftOut(255-i);
    //set latchPin to high to lock and send data
    digitalWrite(latchPin, HIGH);
    delay(250 );
  }
}

void shiftOut(byte dataOut) {
  // Shift out 8 bits LSB first,
  // on rising edge of clock

  boolean pinState;

  //clear shift register read for
  sending data
  digitalWrite(dataPin, LOW);
  digitalWrite(clockPin, LOW);

  // for each bit in dataOut send
  out a bit
  for (int i=0; i<=7; i++) {
    //set clockPin to LOW prior to
    sending bit
    digitalWrite(clockPin, LOW);

    // if the value of DataOut and
    (logical AND) a bitmask
    // are true, set pinState to 1
    (HIGH)
    if ( dataOut & (1<<i) ) {

      pinState = HIGH;
    }
    else {
      pinState = LOW;
    }

    //sets dataPin to HIGH or LOW
    //depending on pinState
    digitalWrite(dataPin, pinState);
    //send bit out on rising edge of clock
    digitalWrite(clockPin, HIGH);
    digitalWrite(dataPin, LOW);
  }

  //stop shifting

  digitalWrite(clockPin, LOW);
}
```

# Project 16 - Code & Hardware Overview

The code for Project 16 is identical to that in Project 15 apart from the addition of

```
shiftOut(255-i);
```

In the main loop. The shiftOut routine sends 8 bits, to the 595. In the main loop we have put 2 sets of calls to shiftOut. One sending the value of 1 and the other sending 255-i. We call shiftOut twice before we set the latch to HIGH. This will send 2 sets of 8 bits, or 16 bits in total, to the 595 chips before the latch is set HIGH to prevent further writing to the registers and to output the contents of the shift register to the output pins, which in turn make the LED's go on or off.

The 2nd 595 is wired up exactly the same as the 1st one. The clock and latch pins are tied to the pins of the first 595. However, we have a wire going from Pin 9 on IC 1 to Pin 14 on IC 2. Pin 9 is the data output pin and pin 14 is the data input pin.

The data is input to Pin 14 on the 1st IC from the Arduino. The 2nd 595 chip is 'daisy chained' to the first chip by Pin 9 on IC 1, which is outputting data, into Pin 14 on the second IC, which is the data input.

What happens is, as you enter a 9th bit and above, the data in IC 1 gets shunted out of its data pin and into the data pin of the 2nd IC. So, once all 16 bits have been sent down the data line from the Arduino, the first 8 bits sent would have been shunted out of the first chip and into the second. The 2nd 595 chip will contain the FIRST 8 bits sent out and the 1st 595 chip will contain bits 9 to 16.

An almost unlimited number of 595 chips can be daisy chained in this manner.

## Exercise

1. Re-create the Knight Rider light effect using all 16 LED's



# Project 17

LED Dot Matrix -



Basic Animation

# Project 17 – LED Dot Matrix – Basic Animation

In this project we are going to use the 74HC595 chips to control a Dot Matrix array of 64 LED's (8x8) and produce some basic animations.

This Project requires the Mini Dot Matrix Display. If your kit has the Red/Green Bi-Colour Display unit then go to Appendix B as the wiring and code is slightly different.

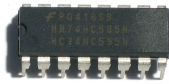
## What you will need

2 x 74HC595 Shift Registers	
8 x 240Ω Resistor	
Mini Dot Matrix	

## Connect it up

The two 595 chips are left the same as in Project 16. Leave the first 8 resistors and remove the 2nd 8. Put your Dot Matrix unit at the end of the breadboard. Make sure it is the right way around. To do this turn it upside down and make sure the words are the right way up then flip it over (from right to left) in your hand. Push it in carefully.

If you take it that bottom left pin of the matrix is Pin 1, bottom right is Pin 8, top right is Pin 9 and top left is Pin 16 then connect jumper wires between the 16 outputs as follows :-

Output	Pin
1	9
2	14
3	8
4	12
5	1
6	7
7	2
8	5
9	13
10	3
11	4
12	10
13	6
14	11
15	15
16	16

Examine the diagrams carefully.

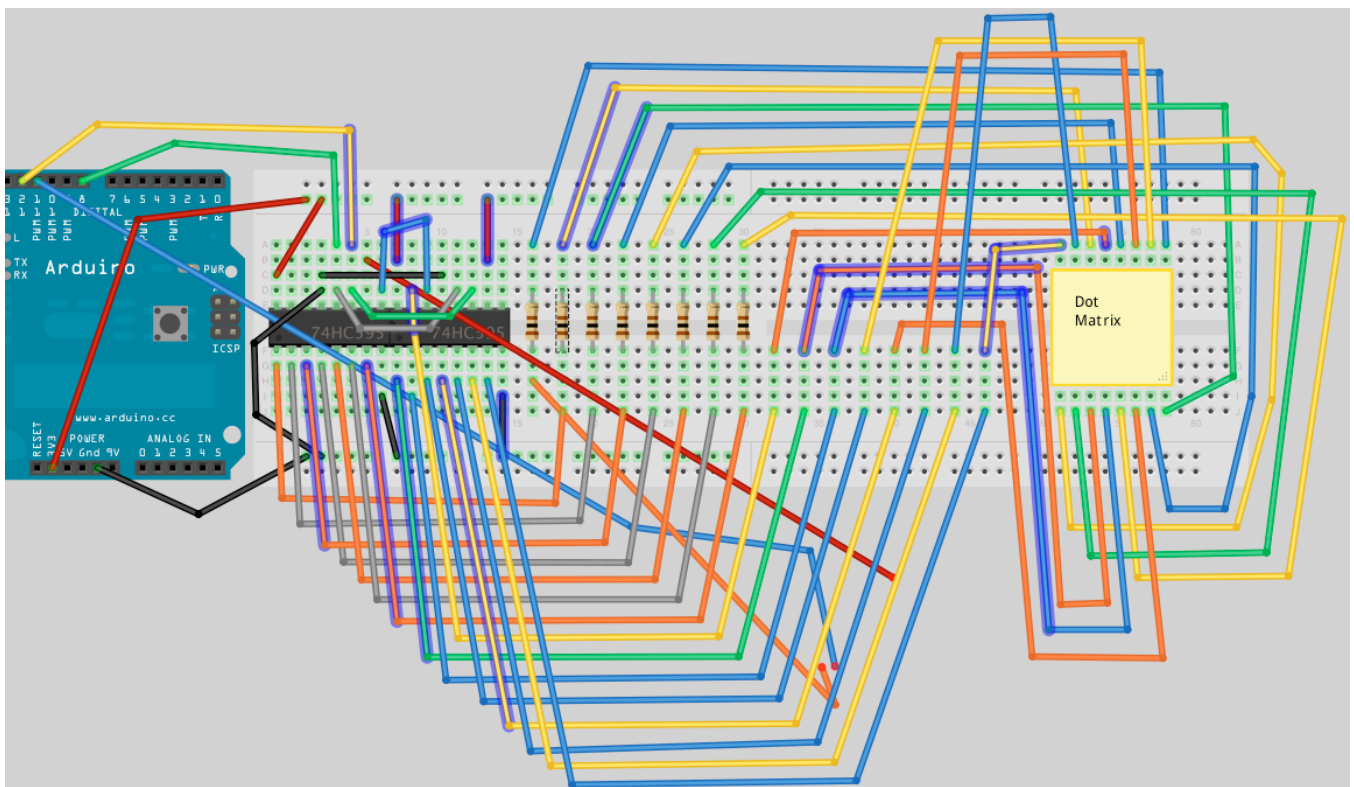

## Enter the Code

```
// Project 17

#include <TimerOne.h>

//Pin connected to Pin 12 of 74HC595 (Latch)
int latchPin = 8;
//Pin connected to Pin 11 of 74HC595 (Clock)
int clockPin = 12;
//Pin connected to Pin 14 of 74HC595 (Data)
int dataPin = 11;

uint8_t led[8];
long counter1 = 0;
long counter2 = 0;

void setup() {
  //set pins to output
  pinMode(latchPin, OUTPUT);
  pinMode(clockPin, OUTPUT);
  pinMode(dataPin, OUTPUT);
  led[0] = B11111111;
  led[1] = B10000001;
  led[2] = B10111101;
  led[3] = B10100101;
  led[4] = B10100101;
  led[5] = B10111101;
  led[6] = B10000001;
  led[7] = B11111111;
  Timer1.initialize(10000);
  Timer1.attachInterrupt(screenUpdate);
}

void loop() {
  counter1++;
  if (counter1 >=100000) {counter2++;}
  if (counter2 >= 10000) {
    counter1 = 0;
    counter2 = 0;
    for (int i=0; i<8; i++) {
      led[i]= ~led[i];
    }
  }
}

void screenUpdate() {
  uint8_t row = B00000001;
  for (byte k = 0; k < 9; k++) {
    // Open up the latch ready to receive data
    digitalWrite(latchPin, LOW);
    shiftOut(~row );
    shiftOut(led[k] ); // LED array

    // Close the latch, sending the data in the registers out to the
    matrix
    digitalWrite(latchPin, HIGH);    row = row << 1;
  }
}
```

```
void shiftIt(byte dataOut) {
  // Shift out 8 bits LSB first,
  // on rising edge of clock

  boolean pinState;

  //clear shift register read for sending data
  digitalWrite(dataPin, LOW);

  // for each bit in dataOut send out a bit
  for (int i=0; i<8; i++) {
    //set clockPin to LOW prior to sending bit
    digitalWrite(clockPin, LOW);

    // if the value of DataOut and (logical AND) a bitmask
    // are true, set pinState to 1 (HIGH)
    if ( dataOut & (1<<i) ) {
      pinState = HIGH;
    }
    else {
      pinState = LOW;
    }

    //sets dataPin to HIGH or LOW depending on pinState
    digitalWrite(dataPin, pinState);
    //send bit out on rising edge of clock
    digitalWrite(clockPin, HIGH);
    digitalWrite(dataPin, LOW);
  }

  //stop shifting
  digitalWrite(clockPin, LOW);
}
```

When this code is run, you will see a very basic animation of a heart that flicks back and forth between a positive and a negative image.

Before this code will work you will need to download the TimerOne library from the Arduino website. It can be downloaded from <http://www.arduino.cc/playground/uploads/Code/TimerOne.zip>

Once downloaded, unzip the package and place the folder, called TimerOne, into the hardware/libraries directory.

# Project 17 – Hardware Overview

For this Project we will take a look at the Hardware before we look at how the code works.

The 74HC595 and how to use them has been explained in the previous projects. The only addition to the circuit this time was an 8x LED Dot Matrix unit.

Dot Matrix units typically come in either an 5x7 or 8x8 matrix of LED's. The LED's are wired in the matrix such that either the anode or cathode of each LED is common in each row. E.g. In a Common Anode LED Dot Matrix unit, each row of LED's would have all of their anodes in that row wired together. The Cathodes of the LED's would all be wired together in each column. The reason for this will become apparent soon.

A typical single colour 8x8 Dot Matrix unit will have 16 pins, 8 for each row and 8 for each column. You can also obtain bi-colour units (e.g. Red and Green) as well as Full Colour RGB (Red, Green and Blue) Units, such as is used in large video walls. Bi or Tri (RGB) colour units have 2 or 3 LED's in each pixel of the array. These are very small and next to each other.

By turning on different combinations of Red, Green or Blue in each pixel and by varying their brightnesses, any colour can be obtained.

The reason the rows and columns are all wired together is to minimise the number of pins required. If this was not the case, a single colour 8x8 Dot Matrix unit would have to have 65 pins. One for each LED and a common Anode or Cathode connector. By wiring the rows and columns together only 16 pin outs are required.

However, this now poses a problem. If we want a particular LED to light in a certain position. If for example we had a Common Anode unit and wanted to light the LED at X, Y position 5, 3 (5th column, 3rd row), then we would apply a current to the 3rd Row and Ground the 5th column pin. The LED in the 5th column and 3rd row would now light.

	1	2	3	4	5	6	7	8
1								
2								
3								
4								
5								
6								
7								
8								

Now let us imagine that we want to also light the LED at column 3, row 6. So we apply a current to the 6th row and ground the 3rd column pin. The LED at column 3, row 6 now illuminates. But wait... The LED's at column 3, row 6 and column 5, row 6 have also lit up.

	1	2	3	4	5	6	7	8
1								
2								
3								
4								
5								
6								
7								
8								

This is because we are applying power to row 3 and 6 and grounding columns 3 and 5. We can't turn off the unwanted LED's without turning off the ones we want on also. It would appear that there is no way we can light just the two required LED's with the rows and columns wired together as they are. The only way this would work would be to have a separate pinout for each LED meaning the number of pins would jump from 16 to 65. A 65 pin Dot Matrix unit would be very hard to wire up and also to control as you'd need a microcontroller with at least 64 digital outputs.

Is there a way to get around this problem? Yes there is, and it is called 'multiplexing' (or muxing).

## Multiplexing

Multiplexing is the technique of switching one row of the display on at a time. By selecting the appropriate columns that we want an LED to be lit in that row and then turning the power to that row (or the other way round for common cathode displays) on, the chosen LED's in that row will illuminate. That row is then turned off and the next row is turned on, again with the appropriate columns chosen and the LED's in the 2nd row will now illuminate. Repeat with each row till we get to the bottom and then start again at the top.

If this is done fast enough (more than 100Hz or 100 times per second) then the phenomenon of 'persistence of vision' (where an afterimage remains on the retina for approx 1/25th of a second) will mean that the display will appear to be steady, even though each row is turned on and off in sequence.

By using this technique we get around the problem of being able to display individual LED's without other LED's in the same column or row also being lit.

For example, we want to display the following image on our display:-

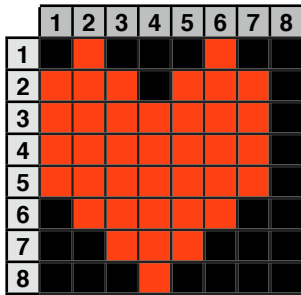

Then each row would be lit in turn like so...

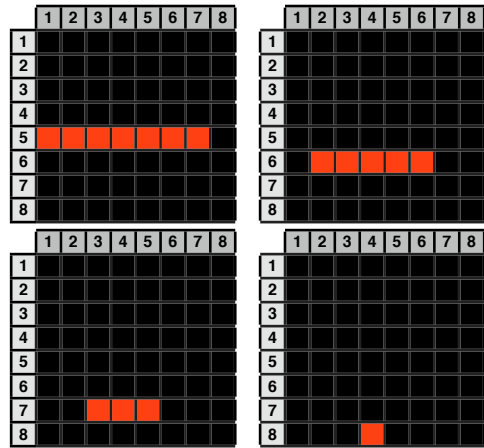
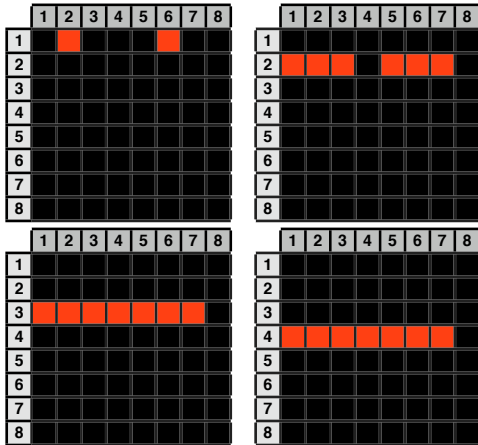

By scanning down the rows and illuminating the respective LED's in each column of that row and doing this very fast (more than 100Hz) the human eye will perceive the image as steady and the image of the heart will be recognisable in the LED pattern.

We have used this multiplexing technique in our Project's code and that is how we are able to display the heart animation without also displaying extraneous LED's.

# Project 17 – Code Overview

The code for this project uses a feature of the Atmega chip called a Hardware Timer. This is essentially a timer on the chip that can be used to trigger an event. In our case we are setting our ISR (Interrupt Service Routine) to fire every 10000 microseconds, which is every 100<sup>th</sup> of a second.

We make use of a library that has already been written for us to enable easy use of interrupts and this is the TimerOne library. TimerOne makes creating an ISR very easy. We simply tell the function what the interval is, in this case 10000 microseconds, and the name of the function we wish to activate every time the interrupt is fired, in our case this is the 'screenUpdate' function.

TimerOne is an external library and we therefore need to include it in our code. This is easily done using the include command.

```
#include <TimerOne.h>
```

After this the pins used to interface with the shift registers are declared.

```
//Pin connected to Pin 12 of 74HC595 (Latch)
int latchPin = 8;
//Pin connected to Pin 11 of 74HC595 (Clock)
int clockPin = 12;
//Pin connected to Pin 14 of 74HC595 (Data)
int dataPin = 11;
```

We now create an array of type uint8\_t that has 8 elements and two counters of type long. An uint8\_t is simply the same as a byte. It is an unsigned integer of 8 bits.

```
uint8_t led[8];
long counter1 = 0;
long counter2 = 0;
```

The led[8] array will be used to store the image we are going to display on the Dot Matrix display. The counters will be used to create a delay.

In the setup routine we set the latch, clock and data pins as outputs.

```
void setup() {
  //set pins to output
  pinMode(latchPin, OUTPUT);
  pinMode(clockPin, OUTPUT);
  pinMode(dataPin, OUTPUT);
}
```

Once the pins have been set to outputs, the led array is loaded with the 8-bit binary images that will be displayed in each row of the 8x8 Dot Matrix Display.

```
led[0] = B11111111;
led[1] = B10000001;
led[2] = B10111101;
led[3] = B10100101;
led[4] = B10100101;
led[5] = B10111101;
led[6] = B10000001;
led[7] = B11111111;
```

By looking at the array above you can make out the image that will be displayed, which is a box within a box. You can, of course, adjust the 1's and 0's yourself to make any 8x8 sprite you wish.

After this the Timer1 function is used. First, the function needs to be initialised with the frequency it will be activated at. In this case we set its period to 10000 microseconds, or 1/100<sup>th</sup> of a second. Once the interrupt has been initialised we need to attach to the interrupt a function that will be executed every time the time period is reached. This is the 'screenUpdate' function which will fire every 1/100<sup>th</sup> of a second.

```
Timer1.initialize(10000);
Timer1.attachInterrupt(screenUpdate);
```

In the main loop we set a counter that counts to 1,000,000,000 to create a delay. This is done by two loops, one that loops 100,000 times and the other one that loops 10,000 times. I have done it this way, instead of using delay() as the current version of the Timer1 library seems to interfere with the delay function. You may try delay() instead and see if it works (updates to the libraries are occurring from time to time). counter1 and counter2 are reset to zero once they reach their targets.

```
void loop() {
  counter1++;
  if (counter1 >=100000) {counter2++;}
  if (counter2 >= 10000) {
    counter1 = 0;
    counter2 = 0;
  }
}
```

Once the end of the delay is reached, a for loop cycles through each of the 8 elements of the led array and inverts the contents using the ~ or NOT bitwise operator.

```
for (int i=0; i<8; i++) {
  led[i]= ~led[i];
}
}
```

This simply turns the binary image into a negative of itself by turning all 1's to 0's and all 0's to 1's.

We now have the `screenUpdate` function. This is the function that the interrupt is activating every 100<sup>th</sup> of a second. This whole routine is very important as it is responsible for ensuring our LED's in the DOT Matrix array are lit correctly and displays the image we wish to convey. It is a very simple but very effective function.

```
void screenUpdate() {
uint8_t row = B00000001;
  for (byte k = 0; k < 9; k++) {
    // Open up the latch ready to receive
    data
      digitalWrite(latchPin, LOW);
      shiftIt(~row );
      shiftIt(led[k] ); // LED array

    // Close the latch, sending the data in
    the registers out to the matrix
    digitalWrite(latchPin, HIGH);    row = row
    << 1;
  }
}
```

An 8 bit integer called 'row' is declared and initialised with the value B00000001.

```
uint8_t row = B00000001;
```

We now simply cycle through the led array and send that data out to the Shift Registers preceded by the row (which is processed with the bitwise NOT ~ to make sure the row we want to display is turned off, or grounded).

```
for (byte k = 0; k < 9; k++) {
  // Open up the latch ready to receive
  data
    digitalWrite(latchPin, LOW);
    shiftIt(~row );
    shiftIt(led[k] ); // LED array
```

Once we have shifted out that current rows 8 bits the value in row is bitshifted left 1 place so that the next row is displayed.

```
row = row << 1;
```

Remember from the hardware overview that the multiplexing routine is only displaying one row at a time, turning it off and then displaying the next row. This is done at 100Hz which is too fast for the human eye to see the flicker.

Finally, we have a `ShiftOut` function, the same as in the previous Shift Register based projects, that sends the data out to the 74HC595 chips.

```
void shiftIt(byte dataOut)
```

So, the basic concept here is that we have an interrupt routine that executes every 100<sup>th</sup> of a second. In that routine we simply take a look at the contents of a screen buffer array (in this case `led[]`) and display it on the dot matrix unit one row at a time, but do this so fast that to the human eye it all seems to be lit at once.

The main loop of the program is simply changing the contents of the screen buffer array and letting the ISR do the rest.

The animation in this project is very simple, but by manipulating the 1's and 0's in the buffer we can make anything we like appear on the Dot Matrix unit from shapes to scrolling text.



**Coming soon.....**

**Project 18 - Dot Matrix - Scrolling Sprite**